



PLANA: Plate 2M BS techn.granite white

14647.06

Wiring devices / Traditional wiring devices / PLANA / Cover plates

Plate 2M BS techn.granite white

2-module cover plate, British Standard, technopolymer, granite white

Product Status

3 - Active

Minimum order quantity

10 NR



Drawings

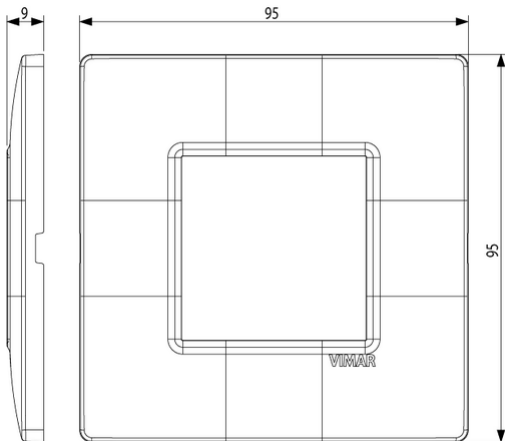

Space view

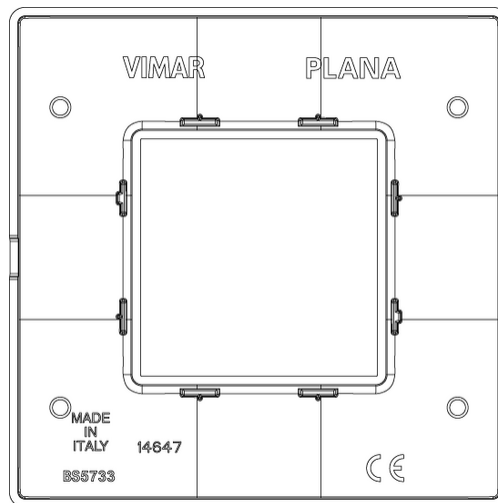

Backside view

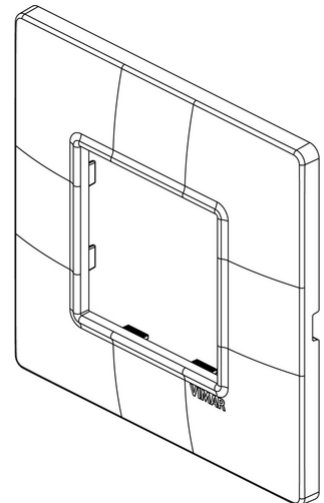

3D View

Certifications

- 00. CE Marking - EU
- 01. IMQ - Italy ([download](#))
- 08. ASTA - UK ([download](#))

Technical data

Class group: Domestic switching devices

Class: Cover frame for domestic switching devices

Number of units: 2

Mounting direction: Horizontal and vertical

Number of device inserts horizontal: 2

Number of device inserts vertical: 1

Number of modules horizontal (module system): 2

Number of modules vertical (module system): 1

With mounting grid: Yes

Suitable for subfloor installation duct box: Yes

Suitable for wall duct: Yes

Suitable for built-in installation: Yes

Label space/information surface: Yes

Material: Plastic

Material quality: Thermoplastic

Halogen free: Yes

Surface protection: Untreated

Surface finishing: Glossy

Colour: White

RAL-number (similar): 9001

Transparent: No

With hinged lid: No

Degree of protection (IP): IP00

Type of fastening: Clamp mounting

Width: 95,00 mm

Height: 95,00 mm

Depth: 9,000 mm

Built-in width: 95,00 mm

Built-in height: 95,00 mm

Diameter bore hole (opening): 0,00 mm

Packaging



8007352371606

Qtà 1 NR

Dim 14.5x9.5x0.9
[cm]

Weight 17.3 [g]



8007352376090

Qtà 10 NR

Dim 11.7x9.8x10.3
[cm]

Weight 213.4 [g]

You may also be interested in



14607 - Frame 2M BS

Legal

Vimar reserves the right to change at any time and without notice the characteristics of the products reported. Installation should be carried out by qualified staff in compliance with the current regulations regarding the installation of electrical equipment in the country where the products are installed. For the terms of use of the information on the product info sheet see [Conditions of Use](#).