



Sail with
By-me Marine.



Automation climbs aboard with a world leader.

By-me Marine was created from three factors of excellence: international leadership for electric supplies in the nautical field, the simplicity of the architecture of the home automation system and the quality of Italian design. These are the strengths that Vimar has transferred into the new system, created on land from research in the residential field, developed in a marine framework to satisfy specific user requirements and tested by the sea over thousands of hours of navigation. If you want to climb aboard the automation system and sail calmly, set sail with By-me Marine.





The automation system at your command.

From the bridge, from the ship owner's cabin or from any other point on the boat it is possible to switch groups of lights on and off or open and close groups of motorized blinds. If you want all the lights and all the blinds, simply program it on the control panel according to your needs.



The whole system is remote controlled.

In every condition By-me Marine gives its best. Just touch one of the many controls on the boat and the whole system is at your command: lights, groups of lights and automations. If you want you can even stay comfortably seated and operate everything with a multi-function remote control.





Evening comes and the scenes change.

After a long day's sailing what could be better than a beautiful evening? There are many scenes. By-me Marine offers up to thirty of them. You program them on the control panel and activate them with a simple button to orchestrate lights, according to your needs and those of your guests.



Choose your style.

For By-me marine two series, Eikon with grey antracite, white and Next devices and two cover plate designs: Classic and Round. And Idea, with grey anthracite and white devices and two cover plate designs Classica and Rondò.

By-me Marine. Automation aboard.

With By-me Marine the automation system climbs aboard the finest boats in automation to yachting. This system is designed and manufactured entirely works, the most popular international standard, therefore able to communicate on high-profile boats. By-me Marine is guaranteed by Vimar, world leader in



Lights and automations control.
The groups of lights and groups of motorized blinds are controlled from here, for the greatest cruise comfort.



Automation control panel.
This is the heart of the system, all the functions are managed and programmed from here by navigating through the display in a straightforward user-friendly manner.



Multi-function remote control.
With the programmable infrared remote control you can manage all the functions: lights, automations and scenes.

the world to transfer the best of by Vimar but open to Konnex net- with the entertainment systems electric installations for boats.



Scene control.

Coordinated actions of lights and automations are controlled from here: up to thirty possible scenes.

The fundamentals of By-me Marine.

Few cables and a great deal of safety.

An automation system is substantially different from a conventional one. There is only one cable that supplies all the devices, and a low voltage BUS cable that transfers information between all the components of the system. This means fewer cables, less weight, smaller sized conduit, and greater safety.

Great flexibility.

The function of each command is not defined: it can vary according to the control panel programming. This means maximum flexibility in configuration. The system can be customized according to the customer's needs and reconfigured without any need for new wiring.

An intelligent system.

Group commands, activation of scenes and time cycles can be accomplished with the control panel without increasing the structural complexity of the system or increasing the number of connections. This means being able to depend on a truly intelligent system.

Safe maintenance.

The commands used by the system are all low voltage and equipped with a self-learning function. This means they can easily be inspected and if necessary replaced even by non-specialized personnel. Extra safety when you're sailing.

General features

Scope

Having a wide and comprehensive range of products for making electrical systems in the residential but also in the tertiary sector makes Vimar one of the sector's consolidated leaders that shows interest in new market niches too.

A special note goes to the world of shipbuilding, a sector where Vimar is one of the world's leading supplier: the finest boats, from large cruise liners to luxurious private yachts, sail safe and in comfort thanks also to the style and technology of Vimar products. From Italy to the United States and New Zealand, the most handsome craft sail the seas with Vimar products on board, valued by designers for their technical features and by users for being practical, safe and reliable to use.

These features are in addition to those of style, which are fundamental for those who deal with the interior decoration of these particular surroundings. The design and wide range of Vimar stylistic solutions, also with a vast choice of natural materials, from wood to stone and glass, besides stainless steel and metal, provide countless choices and possibilities of customization to satisfy everyone's taste and style.

Leadership in the marine market is certainly the result of a series of details and investments made prior to commercialization.

By-me Marine was indeed conceived and designed to ensure the electric and mechanical characteristics are maintained for long periods, often under extremely harsh conditions of use, in the presence of moisture with high salinity, vibration and sudden variation in temperature. To ensure this performance is maintained, 100% production control is done on every single piece produced. Furthermore, each piece is tested before being warehoused.

With the same passion Vimar has tackled the home automation market, a rapidly growing sector that is showing interest in this new system. While initially someone had mistakenly labelled it as an elite, luxury and exclusive solution, home automation soon became the versatile, modular and complete alternative to every technological function now available.

The Vimar home automation system, introduced in 2004 and subsequently developed with the By-me products, is now one of the most valid and competitive systems on the market. The fundamental initial choice, that of opting for an open international standard, Konnex, used by the main companies that deal with building automation, enables communication with all the devices, even if they are made by other companies that use this standard. This is a guarantee also for the future maintenance and implementation of the system. The user interface, easy and customizable, the wide range of functions and the right quality price ratio make By-me a home automation system to fulfil every expectation.

Vimar and the By-me home system has now evolved thru rigid testing to become By-me Marine. By-me Marine is the only fully modular automated marine switching system in the world tested to marine standards. Thus we have By-me Marine, the automation system conceived specifically for yachts. To fully satisfy the specific needs of the sector, that Vimar well knows, starting then with solid experience, the devices of the home automation system most suited for marine installation were identified and specifically redesigned, also to fully satisfy the most restrictive standards in the sector. All the devices have been developed to be used with a supply voltage of 12-24 V or 120 V 60 Hz.

After a significant period of testing, subjecting the products to the worst environmental conditions in the laboratory, field tests were carried out with test installations on vessels that have sailed thousands of miles in real-world conditions of use.

The essential functions of the By-me Marine system are lighting controls, motor controls and programmed scenes. Besides these functions strictly tied to the world of automation, By-me Marine can be integrated into most audio video entertainment systems.

In this way comfort, automation and entertainment become a single system capable of communicating and interacting with the user in a simple and friendly manner, making it possible to forget the technological complexity behind the single systems. Let's see some application examples in detail:

In the main salon, it is possible to govern the many lights and motorized blinds normally present by calling up scenes (Relax, Party, Off General, TV, etc) with dedicated push-buttons or remote controls.

From the cockpit, the Shipowner's cabin or the Captain's quarters it is possible to switch off all the lights of the boat with a single button, or open or close all the motorized blinds at the same time.

Eikon and Idea

By-Me Marine offers two distinct styling choices, the Idea and Eikon series.

Recognized worldwide as the standard switch system for yachting, the Idea series is available with the timeless Classica square edge or the modern Rondò rounded edge cover plates. Components are available in either white or gray for both styles.

In the Eikon series, you may choose between Classic and Round cover plates as well, but in addition to gray and white components, you can choose the exciting "Next" series which offers components in beautiful matt silver.

General features

Main functions

The **By-me** system makes it possible to manage the installation using the following controls:

- Lighting management, with on/off control and light adjustment;
- Shutter control;
- Scenes;
- Function centralization and automation.

• **Functional unit:** part of a device that can be considered as if it were a separate device. Some examples:

1. Device with **two** functional units: in the device with actuator for 2 roller blinds with 8 A relay (art. 01982 for installation on EN50022 rails) each output is a functional unit.
2. Device with **four** functional units: in the device with actuator 4 change-over relays (art. 01981 for installation on EN50022 rails) each output is a functional unit.

During the installation phase, each functional unit of any device must be considered as though it were a separate device. At the design stage, then, it is necessary to plan the functions to create and only afterwards prepare a list of the devices they must activate.

The diagram opposite shows the functional units of a control device with two rocker push buttons (Eikon 20523 series; Idea 16963 series).

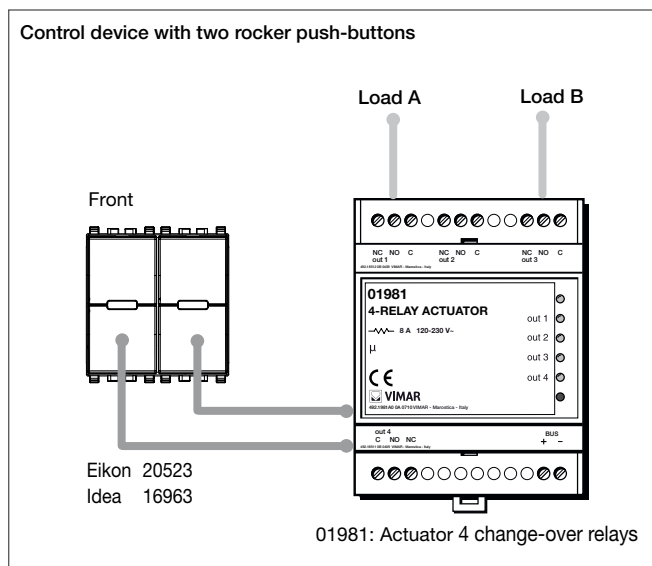

There are no limits on the use of the functional units of a physical device. When a load is to be controlled, it is necessary to provide one control device and one actuator connected to the load.

- **Connection:** logic link between two functional units, which allows a function to be shared (for example: relay actuator

and push-button).

- **Configuration:** operation that can be used to create the logical connection between various functional units
- **Functional group (or Group):** set of functional units connected to each other, which perform a system function (for example: three different push-buttons that control one actuator, and therefore the same load).

The devices that make up a functional group are connected to each other logically, not by conventional wiring.

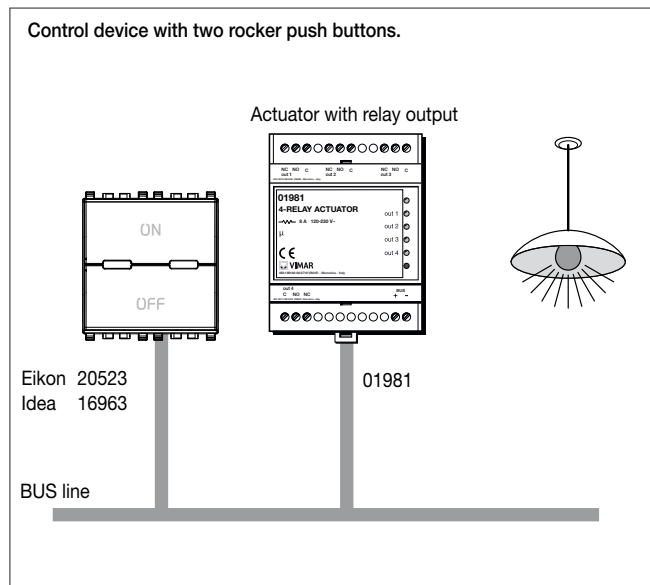

A group must be made up only of homogeneous functional units: any group cannot contain an actuator for rolling shutters and an actuator to control the lighting of a lamp.

To control the switching on of a load from different points, it is sufficient to add more functional units; it is not necessary to modify the wiring.

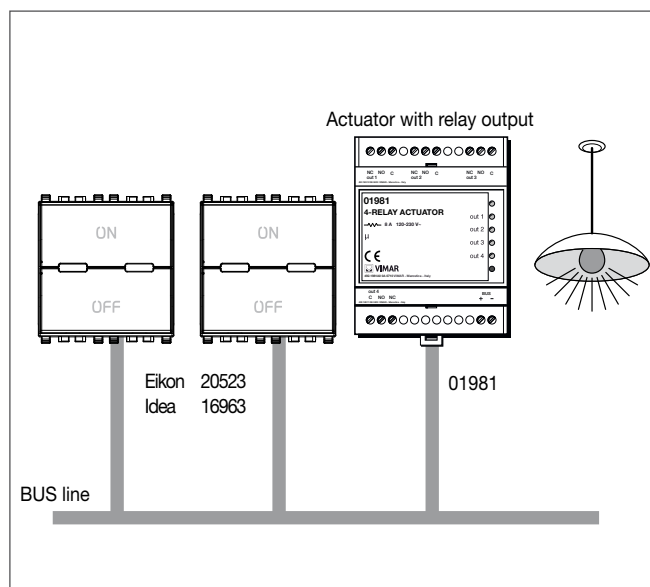

General features

- **Group depth:** number of groups to which one functional unit can belong. Each functional unit can belong to a maximum of 4 different groups.
- **Scene:** a scene is an exact positioning of the actuators in one or more functional groups that can be called up as preferred from a menu on the control panel or with a button configured for this purpose. For example, the rolling shutters could be lowered and a lamp lit in the room at the same time.
- **Parameters:** these can be set at the control unit, and are used to modify and customize the operation of each functional unit. For example, the relay actuator 01981, during configuration, behaves like a two-position stable relay. However, it can be configured as a one-position stable relay; in this case, the actuation time must also be defined.
- **Line:** any set of devices up to 128.
- **Scene depth:** number of scenes to which a group can belong. Each group can belong to a maximum of 4 different scenes.
- **Bus line:** equipment used to carry the electrical or electromagnetic signals associated with the messages between the system devices.
- **Bus system:** set of devices and their interconnections creating applications by using a common communications framework.
- **Command:** functional unit that sends commands and/or statuses over the bus line.
- **Actuator:** functional unit that receives commands and/or statuses from the bus line in order to carry out a predetermined action.

The system in general is made up of three main families of functional unit:

- Controls (for example, push-buttons and sensors)
- Actuators (for example, relays and regulators)
- Controllers (for example, the control unit).

Each line can be composed of at most **128 devices** and needs one or two power supplies depending on the number of devices and the length of the Bus.

System configuration starts with the creation of functional groups (it is better to think in terms of functional groups rather than individual devices), which is the only operation strictly necessary for the system to function. During the installation phase, the first operation is therefore to assume the functions that are to be made available. Subsequent operations, such as placing a number of devices together in one scene or setting a number of automated functions, should be treated as a system customization or as the use of advanced functions.

After the groups have been created, the control panel no longer has any part to play in the way they operate; the devices and related functional groups are “connected” to each other and do not require any intervention by the control unit (the control unit is still needed, however, for managing functions such as scenes, air conditioning, automation, timed base functions).

Topology of a line

During the design phase, it is essential to arrange for a switchboard with sufficient capacity to hold:

- conventional devices, circuit-breakers, etc;
- 1 or 2 power supplies sized 9 EN 50022 modules;
- EN 50022 rail devices such as the actuators (change-over relay outputs, 2 roller blinds, dimmer).
- surge protection devices to protect the installation.

It is advisable to use a dedicate cable trough for the corrugated tubes that carry the Vimar 01841 cable for the Bus line; however, the ones that carry the mains power cables can also be used.

BUS line length: general rules

- Max. distance between power supply and device: 350 m.
- Max. distance between devices: 700 m.
- Max. length of the bus cable: 1000 m.
- Min. distance between 2 power supplies: 40 m.

It is important for the load to be well distributed between the two power supplies.

Essential requirements:

- The distance between two power supplies must never be less than 40 m;
- The load must be well distributed between the two power supplies;
- The two power supplies should be placed at the ends of the one of the circuits of the system that has the largest number of devices or branches.

In all cases, the optimum configuration is where the power supplies are placed as far as possible from each other; this also has a positive effect on the minimum voltage present on the bus.

By-me: basic wiring diagram

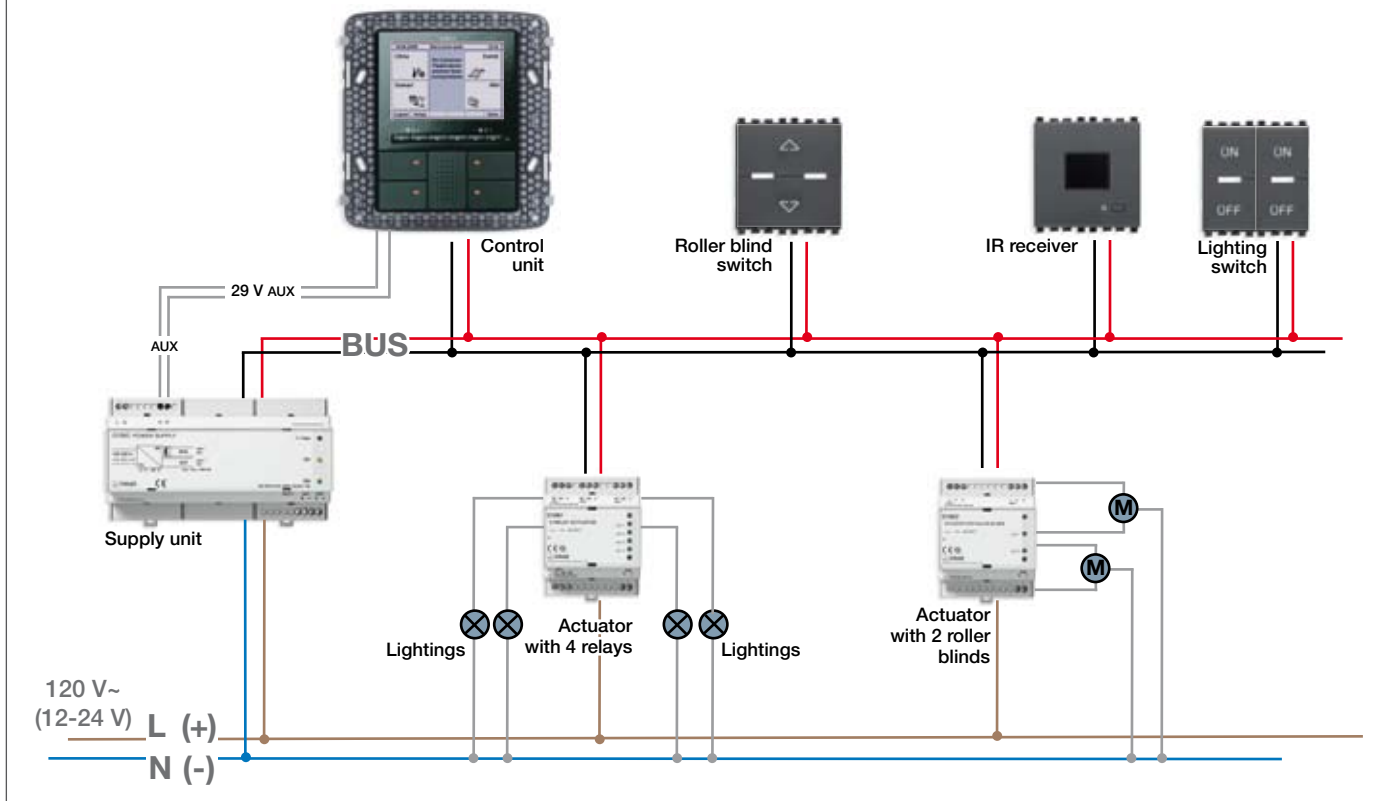

Topology of a line

LINEAR

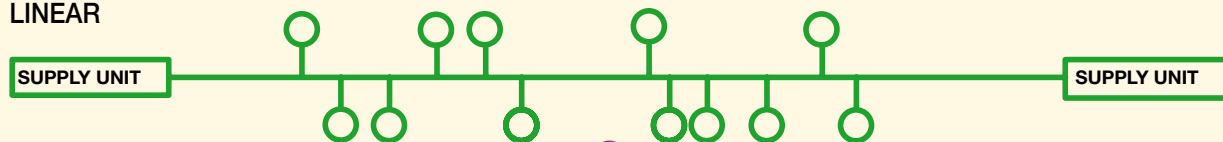

STAR

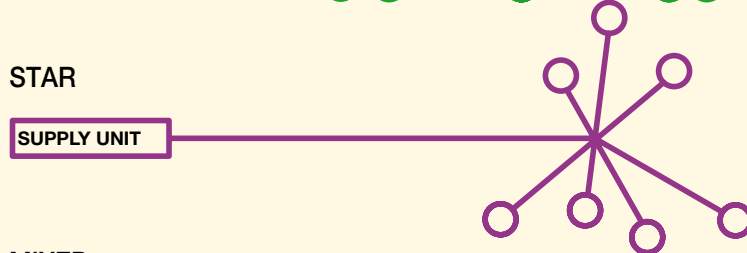

MIXED

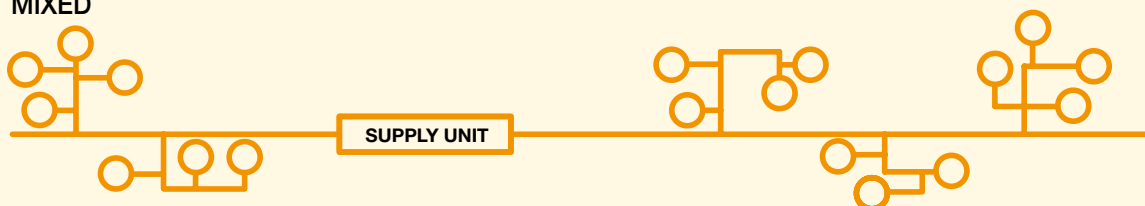

Special features of By-me Marine devices

Characteristics

By-me Marine was indeed conceived and designed to ensure the electric and mechanical characteristics are maintained for long periods, often under extremely harsh conditions of use,

in the presence of moisture with high salinity, vibration and sudden variation in temperature.

Rear views and connections



Front view and inner cross-section

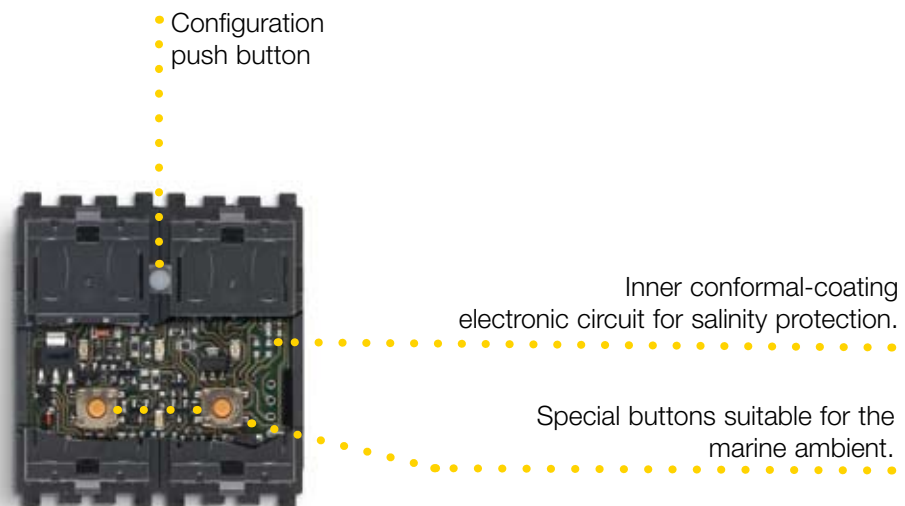

Example of installation

The example locations show the typical settings of a salon with a number of light points (one floor lamp and various wall units) that are all dimmable and a motorized roller blind. The light can be controlled from any point and the roller blind by a rocker switch near the window. Another rocker switch, again at the entrance, enables activating four pre-set scenes, for example:

OFF - all the lights off, roller blinds down;
 TV - floor lamp off, wall light on 50%, roller blinds down;
 PARTY - floor lamp on 100%, wall light on 30%, roller blinds up;
 NIGHT - all the lights on, roller blinds up;
 Installing an infrared receiver enables using the remote control to manage the lights and roller blinds separately from any point in the room or to call up the pre-set scenes.

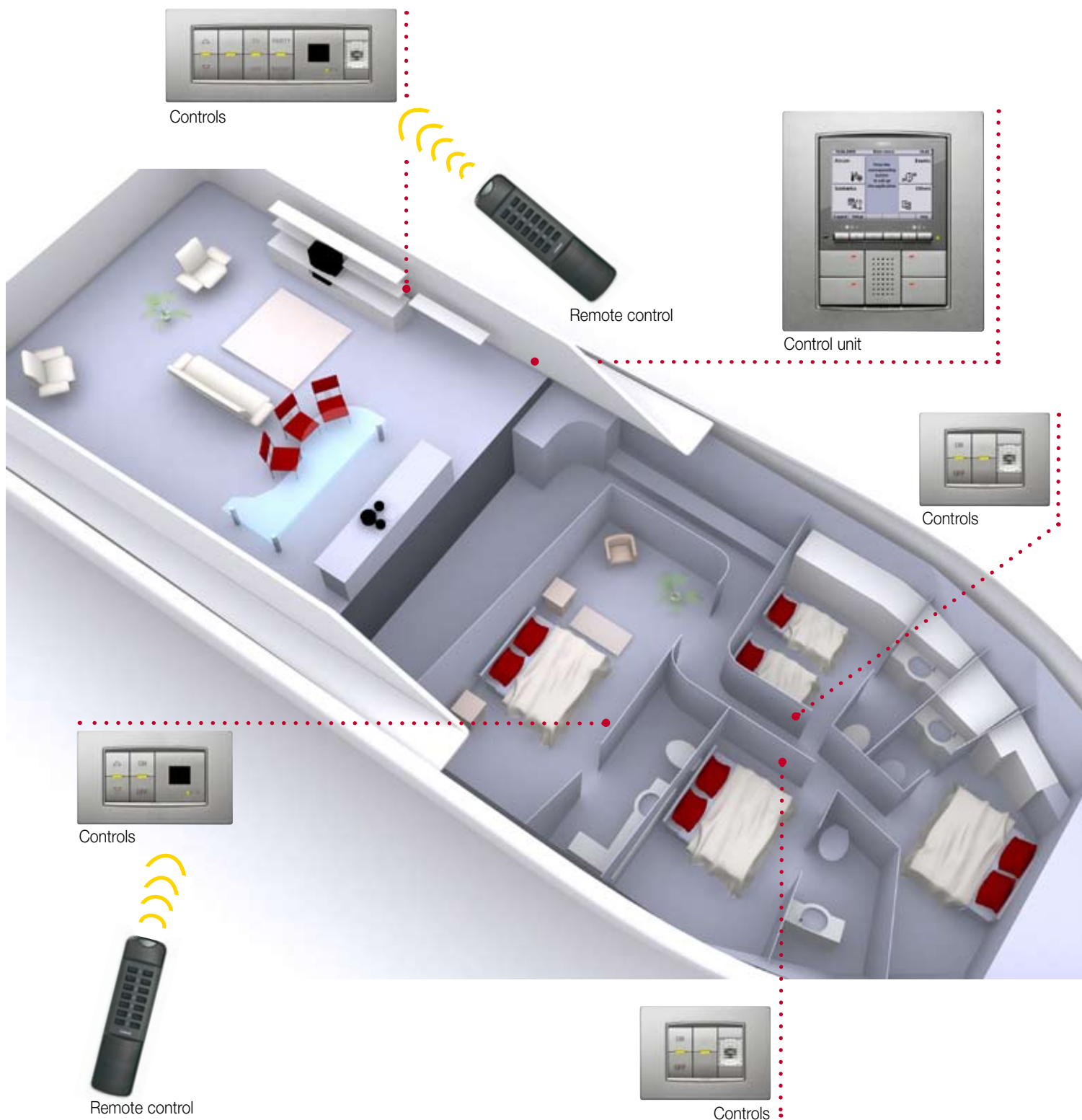

Flush mounting devices - TECHNICAL CHARACTERISTICS

Flush mounting monitor

The control unit By-me for marine sector makes it possible to manage the installation using the following controls:

- Lighting management, with on/off control and light adjustment;
- Shutter control;
- setting up scenes, timed based function and more;

To be installed in 8-module (4+4) flush mounting boxes V71318.

Technical specifications

- Rated supply voltage: 18-29 V d.c. \pm 20%.
- Monitor LCD: 480x234 dot, RGB Delta, 0.150x0.216 (mm) dot pitch.
- Operating temperature: -5 °C - + 45 °C (from indoor use).

Operating

To navigate through the control unit menu, use the 10 buttons on the front, which have different meanings depending on the context and the menu currently selected.

The central unit 20552 has connectors for the BUS and power supply connection.

Conformity to Standards

EMC Directive, Standards EN 50428

For MARINE use, this device has been submitted to the following tests:

IEC 60068-2-52 - Test Kb: Salt mist, cyclic (sodium, chloride solution), IEC 60068-2-6 - Test Fc: Vibration (sinusoidal)

This device complies with part 15 of the FCC Rules (with the limits for a Class B digital device). Operation is subject to the following two conditions: (1) This device may not cause harmful interference, and (2) this device must accept any interference received, including interference that may cause undesired operation.

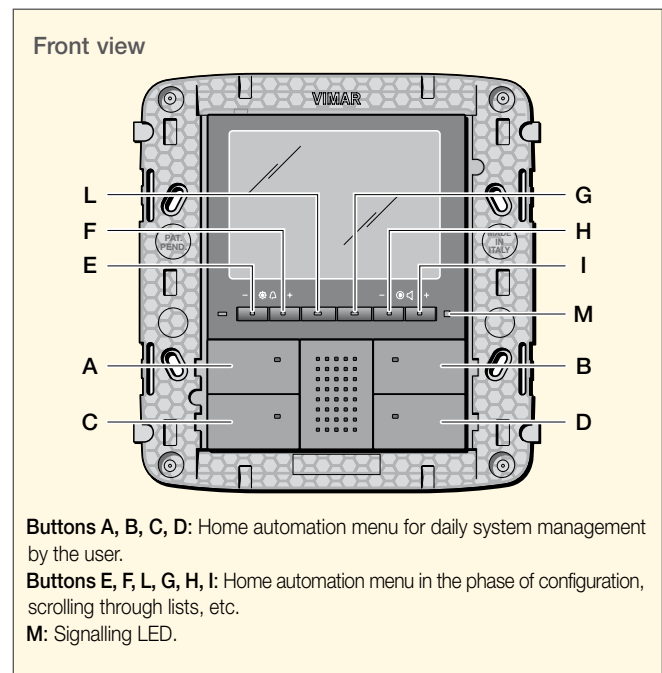

Terminals description:

Terminal	Function
V +	Power supply (+)
V -	Power supply (-)
+	BUS (+)
-	BUS (-)
C	Terminal free
A	Terminal free

- Terminals V+ and V - must be connected to the AUX + - output of the power supply 01980/01970.
- Terminals BUS + and BUS - must be connected to the BUS + - output of the power supply 01980 - 01970.

Back view and drilling template

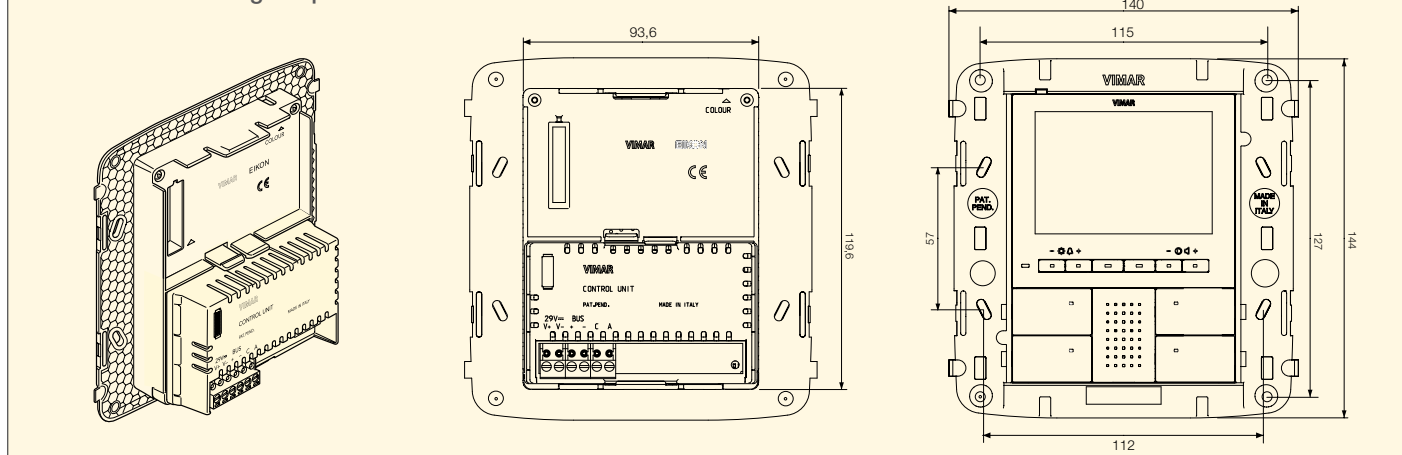

Flush mounting devices

Flush mounting monitor

20552 .B .N Control unit with color monitor, LCD 3,5 in, with built-in 8-module mounting frame for 8-module mounting boxes



20552
grey



20552.B
white



20552.N
Next

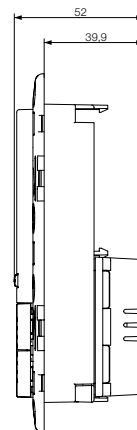

Accessories for flush mounting monitor

20668... 8-module (4+4) Classic cover plate
20698... 8-module (4+4) Round cover plate
V71318 8-module (4+4) flush mounting box, GW 650 °C, light blue



20668...



20698...



V71318

Switches - TECHNICAL CHARACTERISTICS

Rocker push buttons

Device to be used as a double or single push button, depending on the interchangeable button; it can be pressed both at the top and at the bottom.

Technical specifications

- Rated supply voltage: BUS 29 V
- Consumption: 10 mA
- Button: double or single
- Terminals: TP BUS
- Possible functions of each button:
 - ON/OFF switch
 - dimmer control
 - roller blind control
 - activation of 2 scenes.

Configuration

Configuration must be done with the device configuration button.

- Functional blocks: 2, each functional block can belong to at most 4 groups.
- Selecting the functional block (configuration): during group creation, when the control unit requires pressing the device button:
 - press the central configuration button;
 - within 3 s, press one of the two right-hand buttons to select the right functional block or one of the two left-hand buttons to select the left functional block;
 - the red LED will come on and the control unit will configure the functional block; at the end of the operation the red LED will go out.

Conformity to Standards

EMC directive
Standard EN 50428

For MARINE use, this device has been submitted to the following tests:
IEC 60068-2-52 - Test Kb: Salt mist, cyclic (sodium, chloride solution),
IEC 60068-2-6 - Test Fc: Vibration (sinusoidal)

This device complies with part 15 of the FCC Rules (with the limits for a Class B digital device). Operation is subject to the following two conditions: (1) This device may not cause harmful interference, and (2) this device must accept any interference received, including interference that may cause undesired operation.

Front view

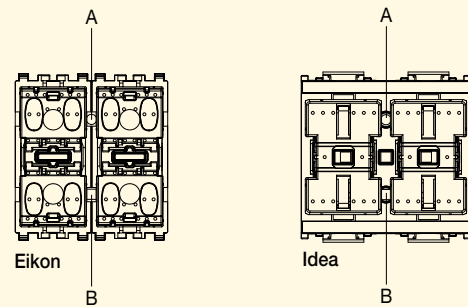

Caption:

- A:** Configuration button
- B:** LED

Back view

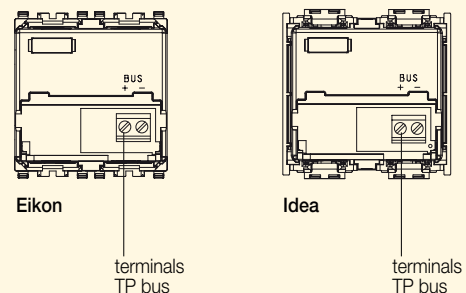

Rocker push button

Two rocker push buttons, to complete with 1- or 2-module buttons - 2 modules

EIKON



20523

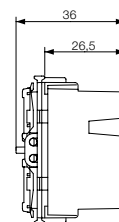

IDEA



16963
grey



16963.B
white

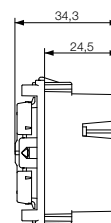

Interchangeable buttons - TECHNICAL CHARACTERISTICS

Button mounting

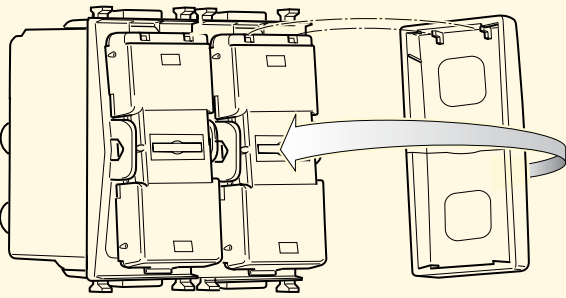

Push button

Interchangeable button

Button removing

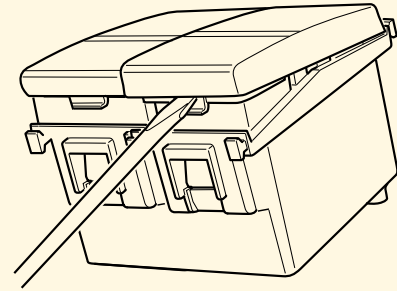

2-module
push button

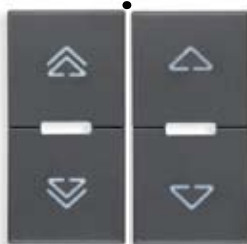

2 1-module buttons

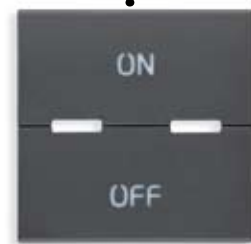













2-module button

Interchangeable buttons











Eikon

For Next version: add .N to the basic code.
For white version: add .B to the basic code.

2-module push button	1-module interchangeable button	2-module interchangeable button
 <p>Rocker push button 20523</p>	 <p>Customizable 20531.S0</p>  <p>Without symbol 20531.S</p>  <p>ON/OFF symbols 20532.20</p>  <p>With directional arrows symbol 20531.21</p>  <p>Regulation symbol 20531.22</p>  <p>With 2 name-plates 20531.2T</p>	 <p>Without symbol 20532.S</p>  <p>ON/OFF symbols 20532.20</p>  <p>Customizable 20532.S0</p>  <p>With directional arrows symbol 20532.21</p>  <p>Regulation symbol 20532.22</p>

Idea

For white version: add .B to the basic code.

2-module push button	1-module interchangeable button	2-module interchangeable button
 <p>Rocker push button 16963 16963.B</p>	 <p>Without symbol 16971</p>  <p>ON/OFF symbols 16971.20</p>  <p>With directional arrows symbol 16971.21</p>  <p>Regulation symbol 16971.22</p>  <p>With 2 name-plates 16971.2T</p>	 <p>Without symbol 16972</p>  <p>ON/OFF symbols 16972.20</p>  <p>With directional arrows symbol 16972.21</p>  <p>Regulation symbol 16972.22</p>

Interchangeable buttons - TECHNICAL CHARACTERISTICS

Eikon: 1-module button

20531.S	.B	.N	Without symbol, for rocker push button
20531.S0	.B	.N	Without symbol, for rocker push button, customizable on request
20531.20	.B	.N	With ON and OFF symbols, for rocker push button

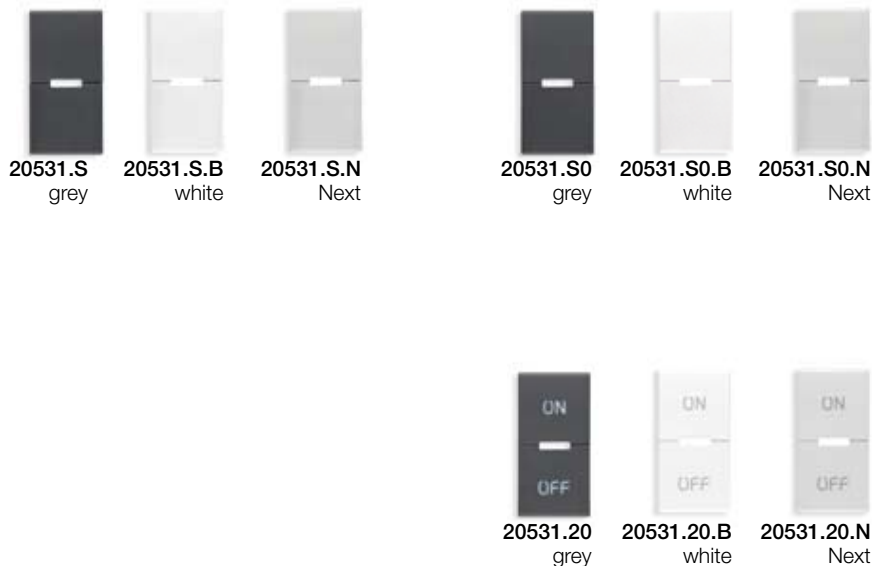

Eikon: 1-module button

20531.21	.B	.N	With directional arrows symbols, for rocker push button
20531.22	.B	.N	With regulation symbols, for rocker push button
20531.2T	.B	.N	With 2 name-plates, for rocker push button

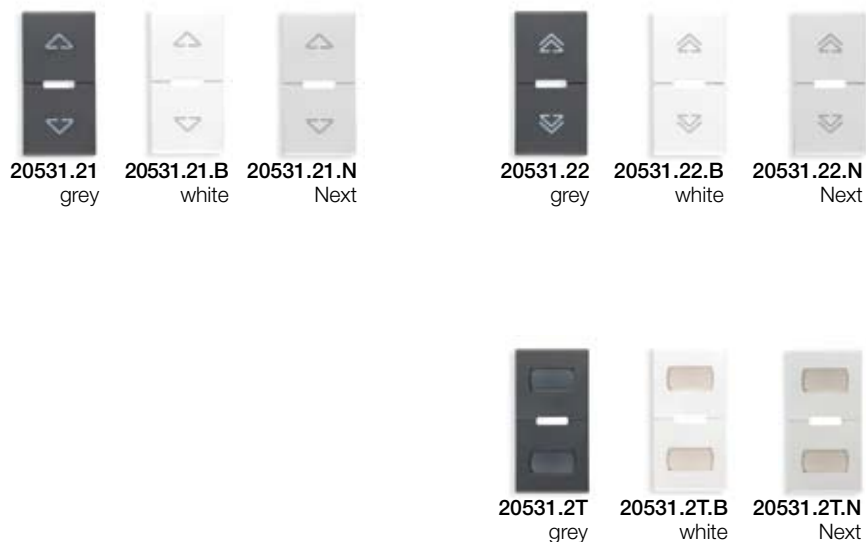

Interchangeable buttons

Idea: 1-module button

16971	.B	Without symbol, for rocker push button
16971.20	.B	With ON and OFF symbols, for rocker push button
16971.21	.B	With directional arrows symbols, for rocker push button



16971
grey



16971.B
white



16971.20
grey



16971.20.B
white



16971.21
grey



16971.21.B
white

Idea: 1-module button

16971.22	.B	With regulation symbols, for rocker push button
16971.2T	.B	With 2 name-plates, for rocker push button



16971.22
grey



16971.22.B
white



16971.2T
grey



16971.2T.B
white

Interchangeable buttons

Eikon: 2-module button

20532.S	.B	.N	Without symbol, for rocker push button
20532.S0	.B	.N	Without symbol, for rocker push button, customizable on request

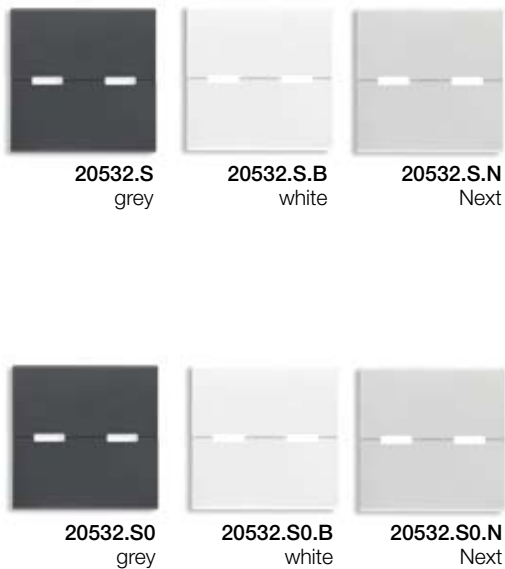

Eikon: 2-module button

20532.20	.B	.N	With ON and OFF symbols, for rocker push button
20532.21	.B	.N	With arrows symbol, for rocker push button
20532.22	.B	.N	With regulation symbol, for rocker push button
20532.1T	.B	.N	With name-plate, for simple push button



Interchangeable buttons

Idea: 2-module button

16972	.B	Without symbol, for simple and rocker push button
--------------	-----------	---

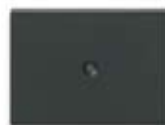

16972
grey



16972.B
white

Idea: 2-module button

16972.20	.B	With ON and OFF symbols, for rocker push button
-----------------	-----------	---

16972.21	.B	With arrows symbol, for rocker push button
-----------------	-----------	--

16972.22	.B	With regulation symbol, for rocker push button
-----------------	-----------	--



16972.20
grey



16972.20.B
white



16972.21
grey



16972.21.B
white



16972.22
grey



16972.22.B
white

Switches - TECHNICAL CHARACTERISTICS

IR remote control receiver

This device receives commands from the remote control 01849 and has 4 channels in reception. It can be used for the functions of an On/Off switch, roll-up blind control, dimmer control, state reversal control (step-by-step), scene activation.

Technical specifications

- Rated supply voltage: BUS 29 V
- Consumption: 10 mA
- Input: remote control 01849 (IR protocol RC5)
- Reception channels: 4
- Terminals: TP BUS
- Possible functions:
 - ON/OFF switch
 - roller blind control
 - dimmer control
 - state reversal (step-by-step)
 - button
 - scene activation

Conformity to Standards

EMC directive

Standard EN 50428

For MARINE use, this device has been submitted to the following tests:

IEC 60068-2-52 - Test Kb: Salt mist, cyclic (sodium, chloride solution),

IEC 60068-2-6 - Test Fc: Vibration (sinusoidal)

This device complies with part 15 of the FCC Rules (with the limits for a Class B digital device). Operation is subject to the following two conditions: (1) This device may not cause harmful interference, and (2) this device must accept any interference received, including interference that may cause undesired operation.

IR remote control

14-channel for infrared receiver.

Technical specifications

- supply: 2 AAA LR03 1,5 V alkaline batteries
- max. range: 5 m
- output: IR RC5 protocol

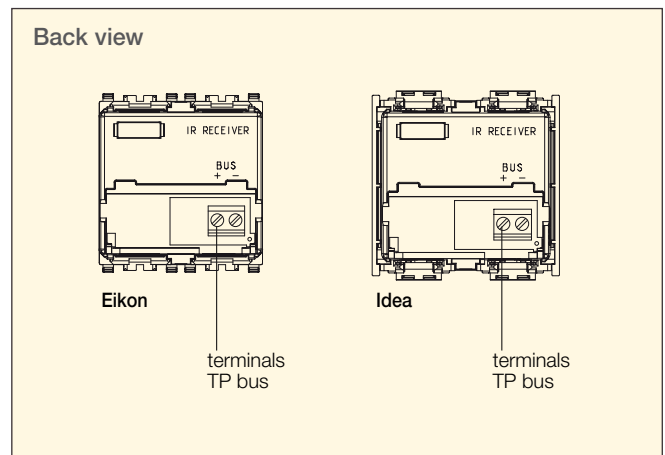
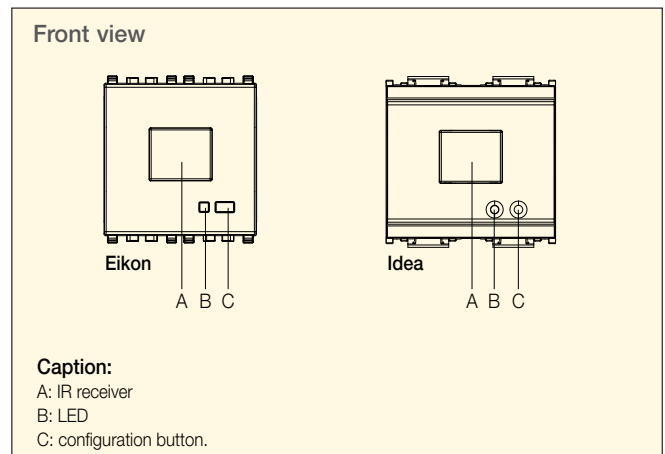

Switches

Remote control receiver

IR remote control receiver - 2 modules

EIKON



20517
grey



20517.B
white



20517.N
Next

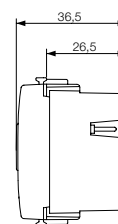

IDEA



16957
grey



16957.B
white

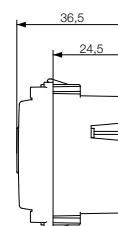

IR remote control

01849 14-channel infrared remote control



01849

120 V~ devices for EN 50022 rail installation - TECHNICAL CHARACTERISTICS

01981 - Relay output actuator

The actuator has 4 independent outputs that can be connected to 4 loads. Each one can have different parameters (set on LCD control unit).

Technical specifications

- Rated supply voltage: BUS 29 V
- Consumption: 14 mA
- Changeover relay outputs
- Controllable loads at 120-230 V~:
 - resistive loads: 8 A (20.000 cycles)
 - incandescent lamps: 8 A (20.000 cycles)
 - fluorescent lamps and energy saving lamps: 1 A (20.000 cycles)
 - electronic transformers: 4 A (20.000 cycles)
 - ferromagnetic transformers: 8 A (20.000 cycles)
 - motors $\cos\phi$ 0.6: 3,5 A (100.000 cycles)
- Terminals:
 - TP bus
 - relay contacts: 4 (C, NC, NO)
- 4 modules of 17.5 mm.

Conformity to Standards

BT directive, EMC directive

Standard EN 50428

For MARINE use, this device has been submitted to the following tests:

IEC 60068-2-52 - Test Kb: Salt mist, cyclic (sodium, chloride solution), IEC 60068-2-6 - Test Fc: Vibration (sinusoidal)

This device complies with part 15 of the FCC Rules (with the limits for a Class B digital device). Operation is subject to the following two conditions: (1) This device may not cause harmful interference, and (2) this device must accept any interference received, including interference that may cause undesired operation.

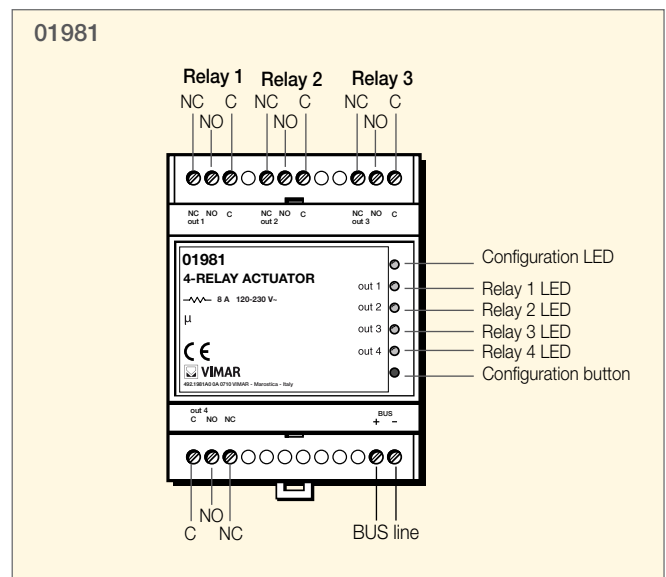
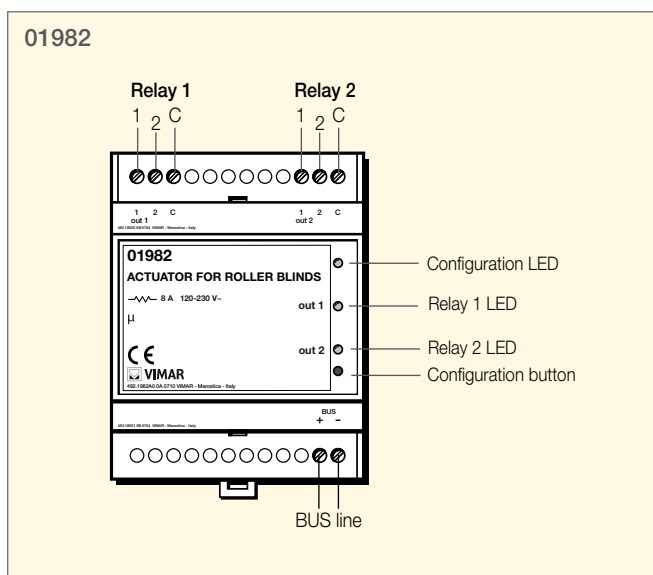

01982 - Actuator with roller blind output relay

The actuator has 2 independent outputs that can be connected to 2 loads. Each one can have different parameters (set on LCD control unit).

Technical specifications

- Rated supply voltage: BUS 29 V
- Consumption: 14 mA
- Relay output
- Controllable loads at 120-230 V~:
 - resistive loads: 8 A (20.000 cycles)
 - motors $\cos\phi$ 0,6: 3,5 A (100.000 cycles)
- Terminals:
 - TP bus
 - relay contacts: 2 (1, 2, C)
 - 1: closed if the button is pressed at the bottom
 - 2: closed if the button is pressed at the top
 - C: common
- 4 modules of 17.5 mm.

Conformity to Standards

BT directive, EMC directive

Standard EN 50428

For MARINE use, this device has been submitted to the following tests:

IEC 60068-2-52 - Test Kb: Salt mist, cyclic (sodium, chloride solution), IEC 60068-2-6 - Test Fc: Vibration (sinusoidal).

This device complies with part 15 of the FCC Rules (with the limits for a Class B digital device). Operation is subject to the following two conditions: (1) This device may not cause harmful interference, and (2) this device must accept any interference received, including interference that may cause undesired operation.

120 V~ devices for EN 50022 rail installation

Actuator with relay output

01981 Actuator with 4 6 A 120-230 V~ change-over relay outputs, on EN 50022 rail installation, occupies 4 17,5 mm modules, RAL 7035 grey



01981

Actuator with roller blind relay output

01982 Actuator for 2 roller blinds with 6 A 120-230 V~ change-over relay output, on EN 50022 rail installation, occupies 4 17,5 mm modules, RAL 7035 grey



01982

120 V~ devices for EN 50022 rail installation - TECHNICAL CHARACTERISTICS

01983 - MASTER dimmer

The device receives commands from the BUS and is able to control the load directly. It can moreover control up to 4 slave dimmers 01984.

Technical specifications

- Rated supply voltage: BUS 29 V
- Consumption: 10 mA
- Terminals:
 - N neutral, \sim load, L phase
 - TP bus
- 4 modules of 17,5 mm
- Lighting level is saved when turned off (unless there is a blackout)
- Soft start: ensures gradual lighting from zero to maximum brightness. This way the life of a lamp is increased by reducing stress on the filament and prevents light flash
- Soft end: ensures a gradual passage from light to dark
- Fuse with high breaking capacity type T5AH incorporated

Controllable loads

- Incandescent lamps 40-500 W
- Ferromagnetic transformers: 40-500 VA
- Electronic transformers with inductive response 40-300 VA (max 5)

Conformity to Standards for 01983 and 01984

For MARINE use, this device has been submitted to the following tests:

IEC 60068-2-52 - Test Kb: Salt mist, cyclic (sodium, chloride solution), IEC 60068-2-6 - Test Fc: Vibration (sinusoidal)

This device complies with part 15 of the FCC Rules (with the limits for a Class B digital device). Operation is subject to the following two conditions: (1) This device may not cause harmful interference, and (2) this device must accept any interference received, including interference that may cause undesired operation.

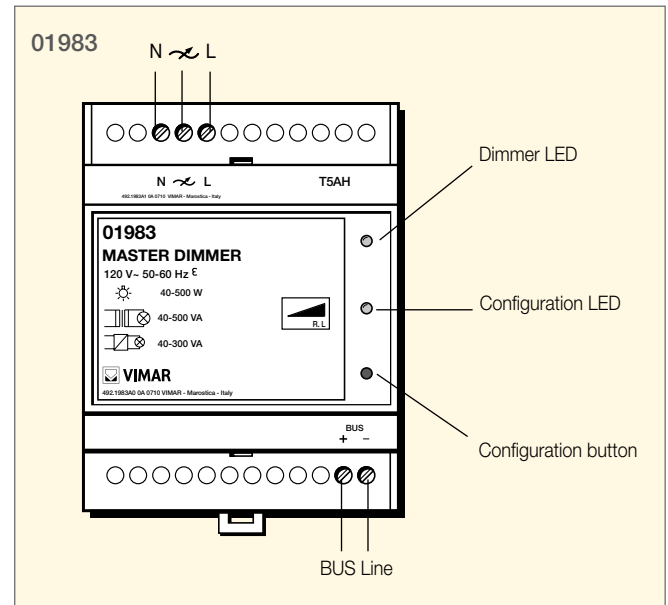
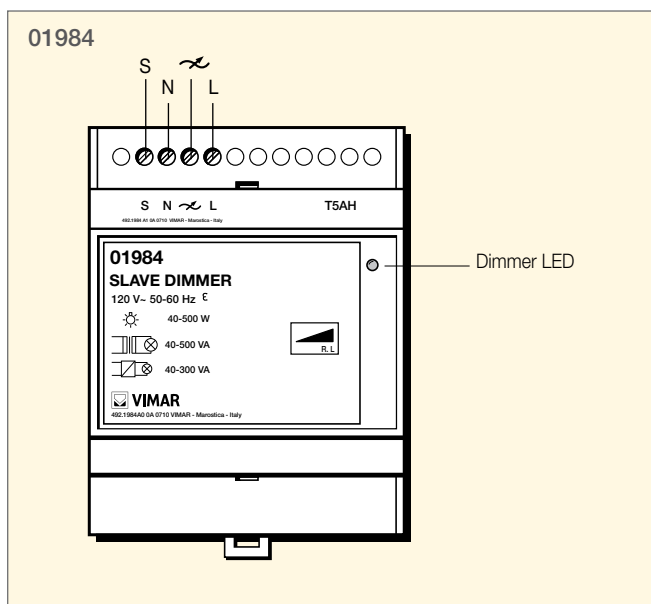

01984 - SLAVE dimmer

It does not need a connection to the BUS but a synchronism signal from a MASTER 01983 dimmer.

Technical specifications

- Supply: 120 V~ 50-60 Hz
- Terminals: S synchronism, N neutral, \sim load, L phase
- 4 modules of 17, 5 mm
- Lighting level is saved when turned off (unless there is a blackout)
- Soft start: ensures gradual lighting from zero to maximum brightness. This way the life of a lamp is increased by reducing stress on the filament and prevents light flash
- Soft end: ensures a gradual passage from light to dark
- Fuse with high breaking capacity type T5AH incorporated

Controllable loads

- Incandescent lamps 40-500 W
- Ferromagnetic transformers: 40-500 VA
- Electronic transformers with inductive response 40-300 VA (max 5).

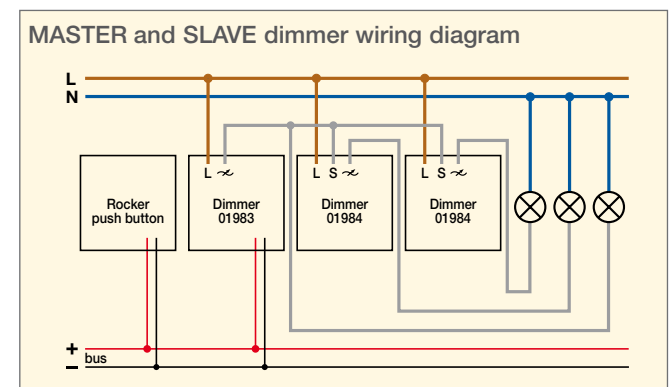

120 V~ devices for EN 50022 rail installation

MASTER dimmer

01983 Dimmer 120 V~ 50-60 Hz for 40-500 W incandescent lamps, 40-500 VA ferromagnetic transformers and 40-300 VA  inductive response electronic transformers, MASTER function, protection fuse, installation on EN 50022 rail, occupies 4 modules of 17,5 mm, RAL 7035 grey









01983

SLAVE dimmer

01984 SLAVE dimmer 120 V~ 50-60 Hz for 40-500 W incandescent lamps, 40-500 VA ferromagnetic transformers and 40-300 VA  inductive response electronic transformers, controlled by MASTER dimmer, protection fuse, installation on EN 50022 rail, occupies 4 modules of 17,5 mm, grey RAL 7035.



01984

Controllable loads	Characteristics controllable transformer	01983 MASTER	1984 SLAVE
	-	40 - 500 W	40 - 500 W
	-	40 - 500 VA	40 - 500 VA
		40 - 300 VA	40 - 300 VA
		-	-

120 V~ devices for EN 50022 rail installation - TECHNICAL CHARACTERISTICS

01980 - Power supply unit

Power unit with decoupling coil.

At most 2 power units can be installed on each line.

Technical specifications

- Power: 120-230 V~ 50-60 Hz
- Consumption:
 - 120 V: 440 mA
 - 230 V: 290 mA
- BUS output voltage: 29 V d.c. (SELV) with decoupling coil
- AUX output voltage: 29 V d.c. (SELV)
- Total max output current: 800 mA
- 9 modules of 17,5 mm

Conformity to Standards

BT directive

EMC directive

Standards EN 60065, EN 50090-2-2.

For MARINE use, this device has been submitted to the following tests:

IEC 60068-2-52 - Test Kb: Salt mist, cyclic (sodium, chloride solution), IEC 60068-2-6 - Test Fc: Vibration (sinusoidal)

This device complies with part 15 of the FCC Rules (with the limits for a Class B digital device). Operation is subject to the following two conditions: (1) This device may not cause harmful interference, and (2) this device must accept any interference received, including interference that may cause undesired operation.

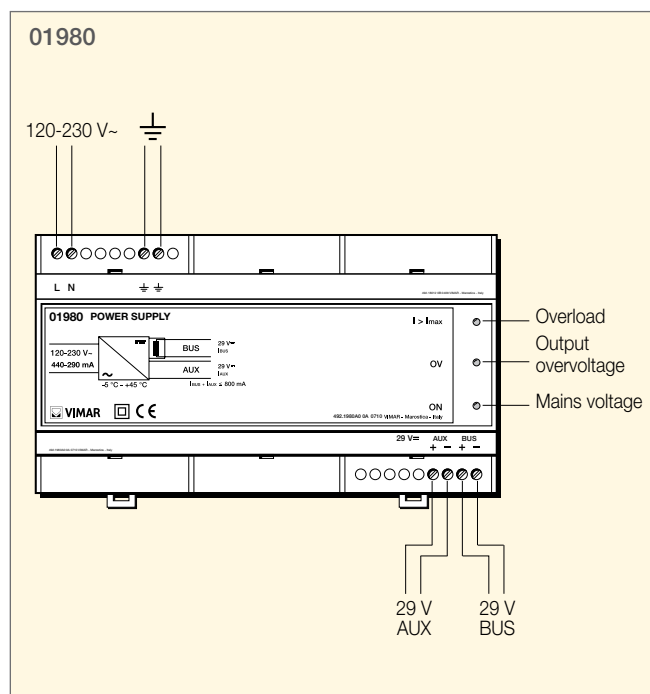

120 V~ devices for EN 50022 rail installation

Power supply unit

01980 Power unit with output 29 V d.c. 800 mA, power supply 120-230 V~ 50-60 Hz, with decoupling coil, installation on EN 50022 rails, occupies 9 modules - grey RAL 7035



01980

Cable

01841 Shielded cable for BUS system, 2x0,50 mm² LSZH sheath, rated voltage 300/500 V - 100 m



01841

12-24 V devices for EN 50022 rail installation - TECHNICAL CHARACTERISTICS

01971 - Actuator with change-over relay output

The actuator has 4 independent outputs that can be connected to 4 loads. Each one can have different parameters (set on LCD control unit).

Technical specifications

- Rated supply voltage: BUS 29 V
- Auxiliary supply voltage: 12-24 V~ ± 10% or 12-24 V d.c. ± 10%
- Consumption:
 - 12 V ~: 400 mA
 - 24 V ~: 240 mA
 - 12 V d.c.: 230 mA
 - 24 V d.c.: 120 mA
- Change-over relay outputs
- Controllable loads at 12-24 V~ or 12-24 V d.c.:
 - resistive loads: 10 A (20.000 cycles)
 - incandescent lamps: 10 A (20.000 cycles)
 - LED spot lamps: 10 A (20.000 cycles)
- 6 modules of 17.5 mm

Conformity to Standards

EMC directive
Standards EN 50428, EN 55025

For MARINE use, this device has been submitted to the following tests:

IEC 60068-2-52 - Test Kb: Salt mist, cyclic (sodium, chloride solution);

IEC 60068-2-6 - Test Fc: Vibration (sinusoidal)

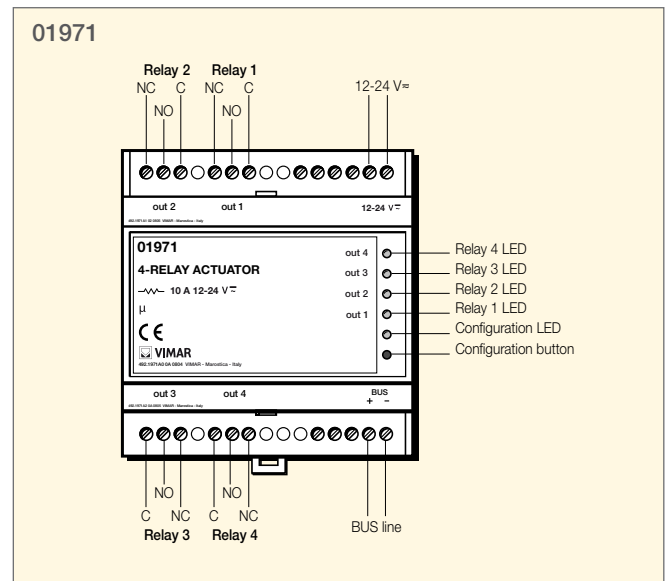

01973 - Dimmer

The device receives commands from the BUS and is able to control the load directly.

Technical specifications

- Rated supply voltage: BUS 29 V
- Supply voltage: 12-24 V~ ± 10% or 12-24 V d.c. ± 10%
- Consumption: 10 mA
- Terminals:
 - + positive, ~ load, - negative
 - TP bus
- 6 modules of 17,5 mm
- Lighting level is saved when turned off (unless there is a blackout)
- Soft start: ensures gradual lighting from zero to maximum brightness. This way the life of a lamp is increased by reducing stress on the filament and prevents light flash
- Soft end: ensures a gradual passage from light to dark
- Fuse with high breaking capacity type 20 AG incorporated

Adjustable loads

- Incandescent lamps: 15 A
- LED spot lamps: 15 A

Parameters

- adjustment speed: low, medium or high;
- LED always off or on only with dimmer on.
- Default parameters: dimmer actuator with medium adjustment speed, LED always off.

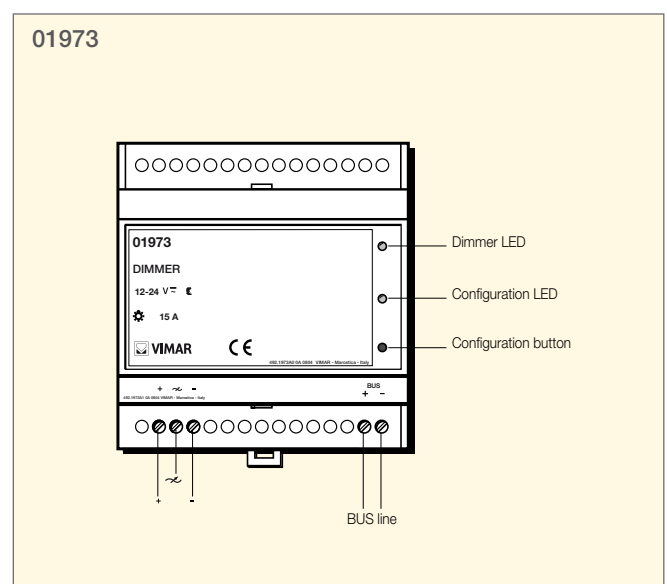

Conformity to Standards

EMC directive
Standards EN 50428, EN 55025

For MARINE use, this device has been submitted to the following tests:

IEC 60068-2-52 - Test Kb: Salt mist, cyclic (sodium, chloride solution);

IEC 60068-2-6 - Test Fc: Vibration (sinusoidal).

12-24 V devices for EN 50022 rail installation

Actuator

01971 Actuator with 10 A, 12-24 V~ 50-60 Hz or 12-24 V d.c. change-over relay output, installation on EN 50022 rail, occupies 6 modules of 17,5 mm, RAL 7035 grey



01971

Dimmer

01973 Dimmer 12-24 V~ 50-60 Hz or 12-24 V d.c. for 15 A incandescent lamps, 15 A LED spot lamps, protection fuse, installation on EN 50022 rail, occupies 6 modules of 17.5 mm, RAL 7035 grey

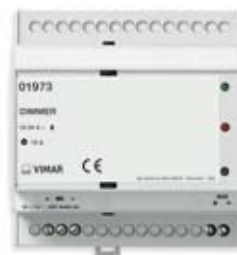

01973

Controllable loads	Characteristics controllable transformer	01973 dimmer
	–	15 A

12-24 V devices for EN 50022 rail installation - TECHNICAL CHARACTERISTICS

01970 - Power supply unit

Power unit with decoupling coil.

At most 2 power units can be installed on each line.

Technical specifications

- Power: 12-24 V~ ± 10% or 12-24 V d.c. ± 10%
- Consumption:
 - 12 V~: 3,5 A
 - 24 V~: 2 A
 - 12 V d.c.: 2,5 A
 - 24 V d.c.: 1,2 A
- BUS output voltage: 29 V d.c. (SELV) with decoupling coil
- AUX output voltage: 29 V d.c. (SELV)
- Total max output current: 800 mA
- 9 modules of 17,5 mm

Conformity to Standards

EMC directive

Standards EN 60065, EN 50090-2-2, EN 55025.

For MARINE use, this device has been submitted to the following tests:

IEC 60068-2-52 - Test Kb: Salt mist, cyclic (sodium, chloride solution),

IEC 60068-2-6 - Test Fc: Vibration (sinusoidal).

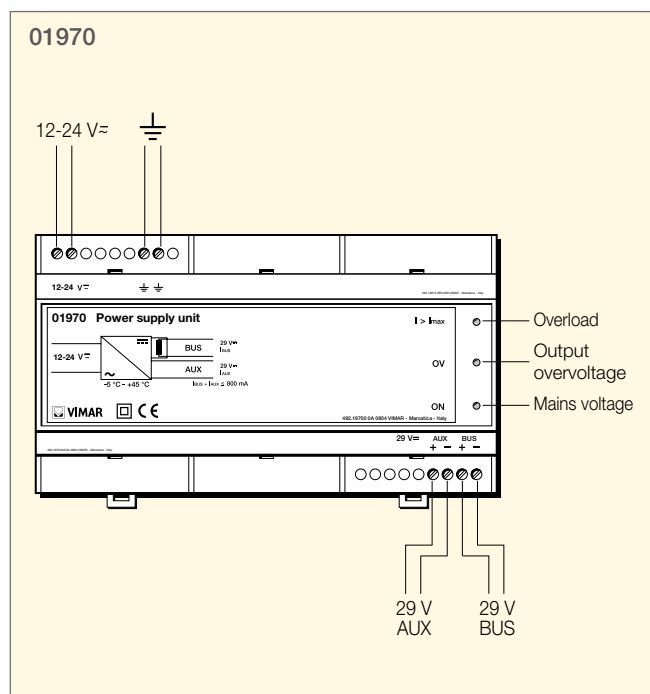

12-24 V devices for EN 50022 rail installation

Power supply

01970 Power supply unit with 29 V d.c. 800 mA output, supply voltage 12-24 V~ 50-60 Hz or 12-24 V d.c., with decoupling coil, installation on EN 50022 rail, occupies 9 modules of 17.5 mm, RAL 7035 grey



01970

Classic cover plate

Bright

(varnished metal)



01 Arctic white



B01 Arctic white
(with white frame)



02 Antique white



B02 Antique white
(with white frame)



03 Heron grey



09 Metallic Atlantic grey



10 Metallic silver



11 Metallic Siena



12 Metallic anthracite



13 Matt silver

Galvanic

(galvanic metal)



21 Satin gold



22 Satin nickel



23 Satin chrome



24 Polished gold



B24 Polished gold
(with white frame)

Inox

(stainless steel)



91 Brushed inox



N91 Brushed inox
(with Next frame)



92 Cotton



93 Brushed anthracite

Wood

(solid wood)



31 African wengé



32 White oak



33 Dark oak



34 Burma teak



35 Italian walnut

Stone

(natural stone)



51 Absolute black



52 Cardoso



53 Carrara white



54 Guatemala green



55 Asiago red

Glass

(crystal)



71 Black ice



72 White ice



B72 White ice
(with white frame)



73 Amber ice



74 Blue ice

Reflex

(technopolymer)



40 Reflex graphite



B41 Reflex ice
(with white frame)



04 Metallic imperial red



05 Metallic Oxford green



06 Metallic Toledo blue



07 Metallic champagne



N07 Metallic champagne
(with Next frame)



08 Metallic titanium



N13 Matt silver
(with Next frame)



14 Matt titanium



N14 Matt titanium
(with Next frame)



15 Matt anthracite



25 Black chrome



36 American cherrywood



37 European maple



56 Atlantis yellow



57 Jerusalem stone



B57 Jerusalem stone
(with white frame)



75 Yellow ice



76 Green ice



81 Silver mirror



N81 Silver mirror
(with Next frame)



82 Ash mirror



83 Bronze mirror

Round cover plate

Bright

(varnished metal)



01 Arctic white



B01 Arctic white
(with white frame)



02 Antique white



B02 Antique white
(with white frame)



03 Heron grey



09 Metallic Atlantic grey



10 Metallic silver



11 Metallic Siena



12 Metallic anthracite



13 Matt silver

Galvanic

(galvanic metal)



21 Satin gold



22 Satin nickel



23 Satin chrome



24 Polished gold



B24 Polished gold
(with white frame)

Inox

(stainless steel)



91 Brushed inox



N91 Brushed inox
(with Next frame)



92 Cotton



93 Brushed anthracite

Wood

(solid wood)



31 African wengé



32 White oak



33 Dark oak



34 Burma teak



35 Italian walnut

Glass

(crystal)



71 Black ice



72 White ice



B72 White ice
(with white frame)



73 Amber ice



74 Blue ice



04 Metallic imperial red



05 Metallic Oxford green



06 Metallic Toledo blue



07 Metallic champagne



N07 Metallic champagne
(with Next frame)



08 Metallic titanium



N13 Matt silver
(with Next frame)



14 Matt titanium



N14 Matt titanium
(with Next frame)



15 Matt anthracite



25 Black chrome



36 American cherrywood



37 European maple



75 Yellow ice



76 Green ice



81 Silver mirror



N81 Silver mirror
(with Next frame)



82 Ash mirror



83 Bronze mirror

Classica cover plate

Die-cast metal



01 White



05 Amaranth



07 Forest green



08 Sage green



10 Ivory



25 Metallized bordeaux



26 Metallized powder blue



27 Iridescent champagne



28 Iridescent Euro blue



29 Iridescent petroleum



42 Cherry briar



46 Slate grey

Natural wood



51 Maple



53 Cherry



55 Walnut



56 Wengé



57 Teak

Technopolymer



01 Bright white



02 Granite white



04 Idea white



07 Ruby red



10 Sapphire blue



47 Satin black



48 Satin grey

Silk



01 White



02 Granite white



04 Idea white



07 Red



10 Blue

Notes: Changes in the grain, colour or evenness of the surface of cover plates made of natural wood are a prized feature and a guarantee of the material's authenticity.



11 Black



12 Cobalt blue



21 Metallized silver



22 Metallized bronze



23 Metallized anthracite



24 Metallized titanium



31 Black chrome



32 Polished gold



33 Matt gold



34 Brushed nickel



36 Chrome



41 Walnut briar



58 Mahogany



13 Emerald green



15 Graphite grey



16 Black



40 Briar



43 Makoré



44 Rosewood



13 Green



15 Graphite



16 Black

Rondò cover plate

Die-cast metal



01 White



05 Amaranth



07 Forest green



08 Sage green



10 Ivory



25 Metallized bordeaux



26 Metallized powder blue



27 Iridescent champagne



28 Iridescent Euro blue



29 Iridescent petroleum



42 Cherry briar



46 Slate grey

Natural wood



51 Maple



53 Cherry



55 Walnut



56 Wengé



57 Teak

Technopolymer



01 Bright white



02 Granite white



04 Idea white



07 Ruby red



10 Sapphire blue



47 Satin black



48 Satin grey

Silk



01 White



02 Granite white



04 Idea white



07 Red



10 Blue

Notes: Changes in the grain, colour or evenness of the surface of cover plates made of natural wood are a prized feature and a guarantee of the material's authenticity.



11 Black



12 Cobalt blue



21 Metallized silver



22 Metallized bronze



23 Metallized anthracite



24 Metallized titanium



31 Black chrome



32 Polished gold



33 Matt gold



34 Brushed nickel



36 Chrome



41 Walnut briar



58 Mahogany



13 Emerald green



15 Graphite grey



16 Black



40 Briar



43 Makoré



44 Rosewood



13 Green



15 Graphite



16 Black

Eikon

Customized switches and cover plates



grey



white



Next



Classic



Round

Possible areas to customize

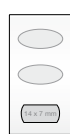
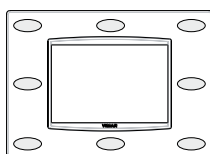

Customizable button (20031...)
Customization:
not visible in darkness (top and central area), visible in darkness (bottom area).

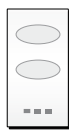

Standard switches or interchangeable buttons (20021..., 20026...)
Customization:
not visible in darkness.

Standard symbols and wordings for Eikon switches (♦ symbols already on product catalogue)

♦ 64	♦ 65	♦ 66	67	68	69	70	71	72	73	74
ON 75	OFF 76	77	78	79	80	81	82	83	84	85
86	87	88	OPEN 289	CLOSE 290	ALARM 91	DO NOT DISTURB 92	COME IN 293	BACK 294	LIGHT 295	GENERAL 296
OUTSIDE 297	GARAGE 98	GARDEN 299	BATHROOM 2100	CELLAR 2101	STOREROOM 2102	STAIRS 2103	ATTIC 2104	TERRACE 2105		

Request for customization

Please contact the commercial network for feasibility, quantity and delivery time.

Warnings

Laser customization advantages

- indelible engraving that does not deteriorate over time;
- high-precision reproduction even of very fine lines and complex images;
- service available even for minimal quantities;
- possibility of ordering the same customization at different times with identical results, because all customizations are stored on magnetic supports.

The few limits of technology

- it is not possible to reproduce coloured images;
- for Eikon, the following finishings of cover plates are not customizable: **Bright:** matt titanium (.14); **Glass:** black ice (.71), blue ice (.74), silver mirror (.81), ash mirror (.82), bronze mirror (.83); **Stone:** Cardoso (.52);
- for Idea, the following finishings of cover plates are not customizable: **Silk:** technopolymer: ruby red (.07), sapphir blue (.10), emerald green (.13), ronce (.40), makoré (.43) rosewood (.44), satin black (.47);
- for wooden cover plate: prices and quantities agreed with the commercial networks.

What to supply

- a printout or transparency of the image to be reproduced, in black-and-white line drawing scaled 2 or 3 times larger than the finished size;

- the image may also be supplied on magnetic support, together with hard copy: DOS or MAC diskette with images in EPS or TIFF format (consult your printer or graphic artist);
- for button engravings, make sure that the desired symbol or label is not already included in the table 'Standard symbols and wordings' below; if so, simply indicate the corresponding code in addition to the article code in your order.

Things to avoid

- do not provide photocopies;
- do not fax image to be reproduced, since the low definition of the fax makes it impossible to reproduce the document in laser quality.

How to proceed

- photocopy this page and fill it in carefully;
- enclose the image to be reproduced, without using paper clips, staples or adhesive tapes;
- deliver all the documentation to your area wholesaler/distributor, who will then forward it to Vimar.

Estimated lead times for devices and cover plates

- 10 working days for the sample;
- 10 working days from confirmation for completed order.

Customized switches and cover plates



grey



white



Classica



Rondò

Possible areas to customize

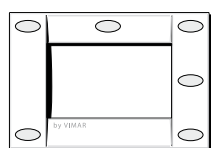
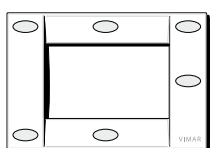

Only for metal cover plate

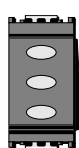

Standard symbols and wordings for Idea switches (♦ symbols already on product catalogue)

01	02	03	04	05	♦ 06	♦ 07	08	09	♦ 10	11
12	13	14	15	16	17	18	19	20	21	open 222
come in 223	bathroom 224	cellar 225	close 226	outside 227	garage 28	general 229	garden 230	back 231	light 232	OFF 33
ON 34	storeroom 235	stairs 236	attic 237	terrace 238	alarm 49	do not disturb 50				

Index

Article	Description	Page
00000		
01841	Shielded BUS system cable - 100m	31
01849	14-channel IR remote control	25
01970	Supply unit from 12-24V to 29V	35
01971	4-relay actuator 24V	33
01973	Dimmer 12-24V	33
01980	Supply unit from 120-230V to 29V	31
01981	4-relay actuator	27
01982	Relay actuator 2 roller blinds	27
01983	MASTER dimmer 120V 500W/VA	29
01984	SLAVE dimmer 120V 500W/VA	29
16000		
16957	Receiver for IR remote control grey	25
16957.B	Receiver for IR remote control white	25
16963	Two rocker push buttons grey	17
16963.B	Two rocker push buttons white	17
16971	Button 1M w/o symbol grey	21
16971.B	Button 1M w/o symbol white	21
16971.20	Button 1M ON/OFF symbols grey	21
16971.20.B	Button 1M ON/OFF symbols white	21
16971.21	Button 1M arrows symbol grey	21
16971.21.B	Button 1M arrows symbol white	21
16971.22	Button 1M regulation symbol grey	21
16971.22.B	Button 1M regulation symbol white	21
16971.2T	Button 1M with 2 name-plates grey	21
16971.2T.B	Button 1M with 2 name-plates white	21
16972	Button 2M w/o symbol grey	23
16972.B	Button 2M w/o symbol white	23
16972.20	Button 2M ON/OFF symbols grey	23
16972.20.B	Button 2M ON/OFF symbols white	23
16972.21	Button 2M arrows symbol grey	23
16972.21.B	Button 2M arrows symbol white	23
16972.22	Button 2M regulation symbol grey	23
16972.22.B	Button 2M regulation symbol white	23
20000		
20517	Receiver for IR remote control grey	25
20517.B	Receiver for IR remote control white	25
20517.N	Receiver for IR remote control Next	25
20523	Two rocker push buttons	17
20531.S	Button 1M w/o symbol rocker button grey	20
20531.S.B	Button 1M w/o symbol rocker button white	20
20531.S.N	Button 1M w/o symbol rocker button Next	20
20531.S0	Button 1M customizable rocker button g	20
20531.S0.B	Button 1M customizable rocker button w	20
20531.S0.N	Button 1M customizable rocker button N	20
20531.20	Button 1M ON/OFF symbols grey	20
20531.20.B	Button 1M ON/OFF symbols white	20
20531.20.N	Button 1M ON/OFF symbols Next	20
20531.21	Button 1M arrows symbol grey	20
20531.21.B	Button 1M arrows symbol white	20
20531.21.N	Button 1M arrows symbol Next	20
20531.22	Button 1M regulation symbol grey	20
20531.22.B	Button 1M regulation symbol white	20
20531.22.N	Button 1M regulation symbol Next	20
20531.1T	Button 1M with name-plate grey	20
20531.1T.B	Button 1M with name-plate white	20
20531.1T.N	Button 1M with name-plate Next	20
20531.2T	Button 1M with 2 name-plates grey	20
20531.2T.B	Button 1M with 2 name-plates white	20
20531.2T.N	Button 1M with 2 name-plates Next	20
20532.S	Button 2M w/o symbol rocker button grey	22
20532.S.B	Button 2M w/o symbol rocker button white	22
20532.S.N	Button 2M w/o symbol rocker button Next	22
20532.S0	Button 2M customizable rocker button g	22
20532.S0.B	Button 2M customizable rocker button w	22
20532.S0.N	Button 2M customizable rocker button N	22

Article	Description	Page
20532.20	Button 2M ON/OFF symbols grey	22
20532.20.B	Button 2M ON/OFF symbols white	22
20532.20.N	Button 2M ON/OFF symbols Next	22
20532.21	Button 2M arrows symbol grey	22
20532.21.B	Button 2M arrows symbol white	22
20532.21.N	Button 2M arrows symbol Next	22
20532.22	Button 2M regulation symbol grey	22
20532.22.B	Button 2M regulation symbol white	22
20532.22.N	Button 2M regulation symbol Next	22
20532.1T	Button 2M with name-plate grey	22
20532.1T.B	Button 2M with name-plate white	22
20532.1T.N	Button 2M with name-plate Next	22
20552	LCD control unit grey	15
20552.B	LCD control unit white	15
20552.N	LCD control unit Next	15
20668.01	Classic plate 8M Bright arctic white	15
20668.02	Classic plate 8M Bright antique white	15
20668.03	Classic plate 8M Bright heron grey	15
20668.04	Classic plate 8M Bright imperial red	15
20668.05	Classic plate 8M Bright Oxford green	15
20668.06	Classic plate 8M Bright Toledo blue	15
20668.07	Classic plate 8M Bright champagne	15
20668.08	Classic plate 8M Bright titanium	15
20668.09	Classic plate 8M Bright Atlantic grey	15
20668.10	Classic plate 8M Bright metallic silver	15
20668.11	Classic plate 8M Bright metallic Siena	15
20668.12	Classic plate 8M Bright anthracite	15
20668.13	Classic plate 8M Bright matt silver	15
20668.14	Classic plate 8M Bright matt titanium	15
20668.15	Classic plate 8M Bright matt anthracite	15
20668.21	Classic plate 8M Galvan.satin gold	15
20668.22	Classic plate 8M Galvan.satin nickel	15
20668.23	Classic plate 8M Galvan.satin chrome	15
20668.24	Classic plate 8M Galvan.polished gold	15
20668.25	Classic plate 8M Galvan.black chrome	15
20668.31	Classic plate 8M Wood African wengé	15
20668.32	Classic plate 8M Wood white oak	15
20668.33	Classic plate 8M Wood dark oak	15
20668.34	Classic plate 8M Wood Burma teak	15
20668.35	Classic plate 8M Wood Italian walnut	15
20668.36	Classic plate 8M Wood American cherry	15
20668.37	Classic plate 8M Wood European maple	15
20668.40	Classic plate 8M techn. Reflex graphite	15
20668.51	Classic plate 8M Stone absolute black	15
20668.52	Classic plate 8M Stone Cardoso	15
20668.53	Classic plate 8M Stone Carrara white	15
20668.54	Classic plate 8M Stone Guatemala green	15
20668.55	Classic plate 8M Stone Asiago red	15
20668.56	Classic plate 8M Stone Atlantis yellow	15
20668.57	Classic plate 8M Stone Jerusalem	15
20668.71	Classic plate 8M Glass black ice	15
20668.72	Classic plate 8M Glass white ice	15
20668.73	Classic plate 8M Glass amber ice	15
20668.74	Classic plate 8M Glass blue ice	15
20668.75	Classic plate 8M Glass yellow ice	15
20668.76	Classic plate 8M Glass green ice	15
20668.81	Classic plate 8M Glass silver mirror	15
20668.82	Classic plate 8M Glass ash mirror	15
20668.83	Classic plate 8M Glass bronze mirror	15
20668.91	Classic plate 8M Inox brushed steel	15
20668.92	Classic plate 8M Inox cotton	15
20668.93	Classic plate 8M Inox anthracite	15
20668.B01	Classic plate 8M Bright arctic white	15
20668.B02	Classic plate 8M Bright antique white	15
20668.B24	Classic plate 8M Galvan.polished gold	15
20668.B41	Classic plate 8M techn. Reflex ice	15

Article	Description	Page
20668.B57	Classic plate 8M Stone Jerusalem	15
20668.B72	Classic plate 8M Glass white ice	15
20668.N07	Classic plate 8M Bright champagne	15
20668.N13	Classic plate 8M Bright matt silver	15
20668.N14	Classic plate 8M Bright matt titanium	15
20668.N81	Classic plate 8M Glass silver mirror	15
20668.N91	Classic plate 8M Inox brushed steel	15
20698.01	Round plate 8M Bright arctic white	15
20698.02	Round plate 8M Bright antique white	15
20698.03	Round plate 8M Bright heron grey	15
20698.04	Round plate 8M Bright imperial red	15
20698.05	Round plate 8M Bright Oxford green	15
20698.06	Round plate 8M Bright Toledo blue	15
20698.07	Round plate 8M Bright champagne	15
20698.08	Round plate 8M Bright titanium	15
20698.09	Round plate 8M Bright Atlantic grey	15
20698.10	Round plate 8M Bright metallic silver	15
20698.11	Round plate 8M Bright metallic Siena	15
20698.12	Round plate 8M Bright anthracite	15
20698.13	Round plate 8M Bright matt silver	15
20698.14	Round plate 8M Bright matt titanium	15
20698.15	Round plate 8M Bright matt anthracite	15
20698.21	Round plate 8M Galvan.satin gold	15
20698.22	Round plate 8M Galvan.satin nickel	15
20698.23	Round plate 8M Galvan.satin chrome	15
20698.24	Round plate 8M Galvan.polished gold	15
20698.25	Round plate 8M Galvan.black chrome	15
20698.31	Round plate 8M Wood African wengé	15
20698.32	Round plate 8M Wood white oak	15
20698.33	Round plate 8M Wood dark oak	15
20698.34	Round plate 8M Wood Burma teak	15
20698.35	Round plate 8M Wood Italian walnut	15
20698.36	Round plate 8M Wood American cherry	15
20698.37	Round plate 8M Wood European maple	15
20698.91	Round plate 8M Inox brushed steel	15
20698.92	Round plate 8M Inox cotton	15
20698.93	Round plate 8M Inox anthracite	15
20698.B01	Round plate 8M Bright arctic white	15
20698.B02	Round plate 8M Bright antique white	15
20698.B24	Round plate 8M Galvan.polished gold	15
20698.N07	Round plate 8M Bright champagne	15
20698.N13	Round plate 8M Bright matt silver	15
20698.N14	Round plate 8M Bright matt titanium	15
20698.N91	Round plate 8M Inox brushed steel	15
	Eikon Classic cover plates	36
	Eikon Round cover plates	38
	Idea Classica cover plates	40
	Idea Rondò cover plates	42
	Eikon customization	44
	Idea customization	45

B.C08014 0A 0806



VIMAR

Viale Vicenza, 14
I 36063 Marostica VI
Tel. +39 0424 488 600
Fax +39 0424 488 709

www.vimar.eu