

09474 Connected dial thermostat

THREE OPERATING MODES (ALTERNATIVE)

Stand alone • Bluetooth • zigbee

Download the View Wireless App from the stores onto the tablet/smartphone you will be using for configuration

When the device is powered for the first configuration, we recommend you search for any new firmware and perform the update.

Depending on the mode you select, you will need:

Stand alone	Bluetooth	zigbee
Nothing else	Gateway art. 09597	Smart Home Hub
	View App for management via smartphone/tablet	Samsung SmartThings Hub
	Amazon Alexa, Google Assistant, Siri (HomeKit) voice assistants for possible voice operation	

Create your Installer account on MyVimar (on-line).

STAND ALONE CONFIGURATION

- Wire all the thermostats.
 - Start the View Wireless App and log in with the credentials you just created.
 - Create the system and the environments.
 - Associate all the thermostats with the environments.
To associate the thermostat:
 - Select "Add" (), choose the environment to place it and give it a name
 - Select ; activate the Bluetooth connection on your tablet/smartphone and approach the thermostat
 - Press for 5 s; the ring flashes blue and association is complete.
 - For each thermostat, set the functions and parameters.
 - Go to the "Temperature control" menu and for each thermostat set the time schedules, the setpoints for the operating modes and the current time.
- Note: In the event of a mains power outage and subsequent restoration, the product will return to operating in manual mode with the last set point set. You will therefore need to set the date/time (see paragraph entitled "Thermostat date/time setting") to restore operation in automatic mode.

CONFIGURATION IN Bluetooth

- Wire all the devices in the system (2-way switches, relays, thermostats, gateway, etc.).
- Start the View Wireless App and log in with the credentials you just created.
- Create the system and the environments.
- Associate all the devices with the environments, except for the gateway (which should be associated last).
To associate the thermostat:
 - Select "Add" (), choose the environment to place it and give it a name
 - Select ; activate the Bluetooth connection on your tablet/smartphone and approach the thermostat
 - Press for 5 s; the ring flashes blue and association is complete.
- For every device, set the function, the parameters and any accessory devices (magnetic contact art. 03980 and related function).
- Transfer the configuration of the devices to the gateway and connect it to the Wi-Fi network.
- Transfer the system to the Administrator user (who must have created his/her profile on MyVimar).

For full details, see the View Wireless App manual that can be downloaded from the www.vimar.com website.

CONFIGURATION IN zigbee

- Perform the procedure set out in points 1 and 2 of configuration in Bluetooth.
- Associate the thermostat directly with a ZigBee hub (for instance a SmartThings Hub).
- Download the Zigbee software onto the thermostat using the View Wireless App (see the View Wireless App manual). Press the button until the display shows "bt" and the ring flashes blue. Perform the same procedure to update the software on the device.
 - After conversion to Zigbee technology (or the software update), the thermostat automatically goes into pairing mode for 5 minutes, during which the ring flashes white. If the thermostat is not in pairing mode, cut off the power supply and restore it after a few seconds.
 - Associate the thermostat following the procedure envisaged by the ZigBee hub.
 - Associate the module following the procedure envisaged by the ZigBee hub (see the hub manufacturer's documentation).

Set the thermostat parameters.
Within the first 10 minutes of powering the thermostat (already associated with the ZigBee hub) or after restarting at the end of association with Zigbee, press the button relating to the parameter to edit as shown below.

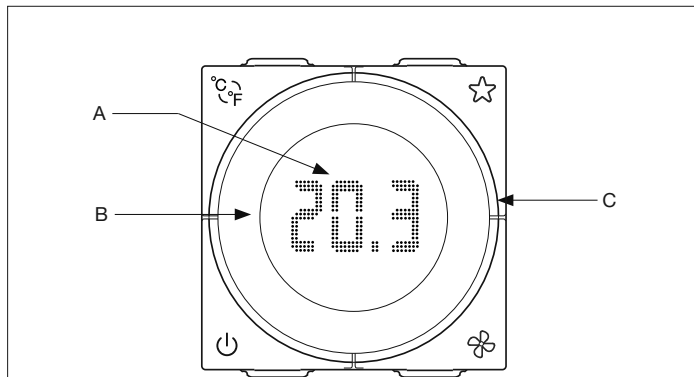

	<ul style="list-style-type: none"> Short press = degrees Celsius/Fahrenheit selection Long press (5 s) = the thermostat enters the configuration phase (bt) Prolonged press (30 s) within the first 5 min of powering = device reset (rst)
	<p><i>Programmable function key:</i></p> <ul style="list-style-type: none"> Display brightness and RGB LED in standby setting <ul style="list-style-type: none"> 1st press = current brightness display Subsequent presses = cyclic display of available brightness values L-3 (high), L-2 (medium), L-1 (low) and L-0 (off). Heating/air conditioning mode selection Call up scenario
A	<p><i>Display</i></p> <ul style="list-style-type: none"> bt = devices in Bluetooth configuration off = thermostat off; on = thermostat on °C = degrees Celsius; °F = degrees Fahrenheit L-0, L-1, L-2, L-3 = brightness in standby (from the lowest to the highest) H = heating; C = air conditioning opn* = window open (associated with the thermostat via magnetic contact art. 03980 or with an input of the 3in 1out module art. 03983)
B	Set point adjustment dial
C	Lightable ring
	<ul style="list-style-type: none"> Power on and off. <p>Upon power on or off, the thermostat starts in the last operating mode associated with it set via the View* or View Wireless* App.</p>
	<p><i>Programmable function key:</i></p> <ul style="list-style-type: none"> Heating/air conditioning mode selection Fan speed setting

* Only for Bluetooth technology





Ring signalling	
All flashing blue = thermostat in configuration mode	
All lit amber* = thermostat in heating mode and relay active	
All lit blue** = thermostat in air conditioning mode and relay active	
1	<ul style="list-style-type: none"> Lit amber* = thermostat in heating mode and relay not active Lit blue** = thermostat air conditioning mode and relay not active <p>In standby, the brightness is set during configuration; otherwise, the value is the maximum one.</p>
2***	<ul style="list-style-type: none"> Flashing red = the thermostat, in automatic mode, has lost the hourly value and has therefore switched to manual mode. <p>When it receives the hourly value from the gateway or the View Wireless App again, the thermostat returns to automatic mode and the flashing ends.</p>

* Amber with automatic colour or of the selected colour.

** Blue with automatic colour or of the selected colour.



*** Only for Bluetooth technology

1. Set the summer/winter offset temperatures

- Press the  button for 5 seconds to start setting the "heating offset temperature", with a 2-minute timeout. The ring flashes amber and the display shows "H", to indicate the setting of the "heating offset temperature". Turn the dial to select the desired offset temperature; the ring flashes amber and the display shows the offset temperature.
- Press the  button for 5 seconds to confirm the "heating offset temperature". The display shows "C" and the ring flashes blue at maximum brightness and the 2-minute timer for setting the "cooling offset temperature" begins. Turn the dial to select the offset temperature. Press the  button for 5 seconds to confirm the "cooling offset temperature"; the ring flashes blue and the display shows the offset temperature.
- Press the  button for 5 seconds to confirm the "cooling offset temperature". The ring flashes blue three times to confirm saving.

Note: if you don't want to save the values set, allow the 2-minute timeout to expire.

2. Set the colour of the ring

- Press the  button for 5 seconds to begin the 2-minute timeout, during which time you can set the LED colour of the ring. The display shows "LeD" to indicate "colour of the ring"; this colour changes every time you press the "Display brightness" push button. Press the  button for 5 seconds to confirm the desired colour; the LED of the ring flashes 3 times to confirm saving.

Note: if you don't want to save the colour set, allow the 2-minute timeout to expire.

Indication of mode with Zigbee technology







Colour of the ring	Display	Meaning
Flashing white (for max. 5 min.)	Temperature detected	Association with the hub under way
Flashing blue (for max. 2 min.)	bt	Reception of a firmware update in progress
Blue permanently lit	bt	Device associated with the smartphone via Bluetooth
Flashing amber (for max. 2 min.)	H	Calibration of the heating temperature
Flashing blue (for max 2 min.)	C	Calibration of the cooling temperature
3 blue flashes		Calibration saved
Current colour permanently lit (for max. 2 min.)	LeD	Ring colour setting
3 flashes	-	Ring colour saved
3 quick green flashes	-	Device correctly associated with the Smart Hub

RESETTING THE THERMOSTAT

The reset restores the factory settings. Within the first 5 minutes of powering, press  for 30 s; during these 30 s the ring flashes blue and then emits 2 white flashes to confirm the operation.

THERMOSTAT DATE/TIME SETTING

In the event of a mains voltage outage, if the thermostat is configured in Stand alone and the "ON Mode"- "Automatic" is set, when the power is restored the date and time can be inserted directly on the device without using the App.

1. Press ; you have entered the "Time entry" phase; during this phase, keys  and  are not operational.
2. Turn the ring and display the number representing the desired day of the week (1=Monday, 2=Tuesday, 3=Wednesday and so on).
3. Confirm by pressing ; now proceed and set the time.
4. Turn the ring and display the number representing the hours (00, 01, 02 and so on all the way to 23).
5. Confirm by pressing ; now proceed and set the minutes.
6. Turn the ring and display the number representing the minutes (00, 01, 02 and so on all the way to 59).
7. Confirm by pressing ; the thermostat returns to the status it was in before the blackout and the display and part 2 of the ring stop flashing.

N.B. During the selection phases, the display and part 2 of the ring flash and key  flashes red. If no selection is made within 2 minutes, the thermostat quits the procedure.

To change the time without a blackout press  for 5 s and perform the procedure from point 1 to 7 above.

INSTALLATION RULES.



- Installation and configuration must be carried out by qualified persons in compliance with the current regulations regarding the installation of electrical equipment in the country where the products are installed.
- The C-NO contact of the relay must be protected against overloads by installing a device, fuse or automatic 1-way switch, with a rated current not exceeding 10 A.
- Do not connect a SELV circuit to the C-NO terminals as there is no double insulation with on the L-N terminals
- The device must be installed in a flush mounting box or surface mounting box with the related mounting frames and cover plates, at a height of 1.5 m above floor level, in a suitable position for the correct detection of the room temperature, avoiding installation in recesses, behind doors and curtains, areas affected by heat sources or subject to the flow of forced heating/cooling ventilation sources or affected by atmospheric factors. Avoid in particular installation on perimeter walls or in association with devices which generate heat (e.g. dimmers or lamps).

CHARACTERISTICS.

- Rated supply voltage: 100-240 V~, 50/60 Hz.
- Dissipated power: 0.55 W.
- RF transmission power: < 100mW (20dBm).
- Frequency range: 2400-2483.5 MHz.
- Terminals:
 - 2 terminals (L and N) for line and neutral
 - 2 terminals for external temperature probe (art. 02965.1)
- Maximum length of the external sensor connection cable: 10 m.
- Use a twisted cable with a minimum cross-section of 0.5 mm² (art. 01840).
- The external temperature probe is only managed in the Bluetooth technology system.**
 - 2 C-NO relay terminals.
- Relay output with voltage-free contact: 5(2) A 240 V~
- Current settable setpoint: 4°C - 40°C.
- Settings for 3-speed fan coil: V1, V2, V3, Auto
- Speed settings for proportional fan coil: 33%, 66%, 100%, Auto
- Can be associated with one or more thermostatic heads art. 03989
- Temp. measurement precision (integrated probe): 0.5°C between +15°C and 30°C, 0.8°C at the extremes
- For use for Heating/Air Conditioning (winter/summer).
- Operating modes: Automatic, Manual, Reduction, Economy, Protection, Off, Timed Manual (only for Bluetooth technology system).
- Temperature control algorithms: ON/OFF or configurable PID (only for Bluetooth technology).
- 4 front buttons for control and configuration/reset.
- RGB LED for configuration status (flashing blue) and output status (configurable colour) signalling.
- Operating temperature: T40 (0 °C +40 °C) (indoor use).
- Protection degree: IP30.
- ErP classification (EU Reg. 811/2013): - ON/OFF: class I, contribution 1%. - PID: class IV, contribution 2%.
- Device in class II
- Number of manual cycles: 3,000
- Number of automatic cycles: 100,000
- Type of contact opening: micro-disconnection
- Type of action: 1BU
- Tracking index: PTI175
- State of pollution: 2
- Rated pulse voltage: 4000 V
- Software class: A
- Reading resolution: 0.1 °C
- Settings resolution: 0.1 °C
- Update of temperature displayed: every 10 s
- Room temperature display: 0 °C +40 °C
- Hysteresis adjustable via App: from 0.1 °C to 1 °C
- Hourly temperature setting (via App)
- Room temperature during transportation: -25 °C +60 °
- Clock error: ≤ 1 s per day
- Configuration via View Wireless App for stand alone and Bluetooth technology system
- Controllable via View App, Amazon Alexa, Google, Siri and Homekit voice assistant for Bluetooth technology system

OPERATION IN Bluetooth technology MODE.

In Bluetooth technology mode, the device should be configured using the View Wireless App. The App can be used to set the parameters listed in the table.

Menu	Parameters
LED backlighting → Type of backlighting	Seasonal colour/Customised colour
LED backlighting → Colour	RED, GREEN, BLUE, AMBER, WHITE, CYAN, MAGENTA, YELLOW
LED backlighting → Brightness on standby	0, 1, 2, 3
Function → Summer temperature calibration	From -5 °C to +5 °C, in 0.1°C steps
Function → Winter temperature calibration	From -5 °C to +5 °C, in 0.1°C steps
Function → External probe configuration	Off/Average/Exclusive/Screened Limitation
Function → Relay configuration	From 20°C to +35°C, in 0.1°C steps
Function → Screened threshold	NO/NC
Function → Window reaction time	From 0 to 30 min, in 1-min steps
Function → Window reactivation time	1h/2h/4h/8h/12h/Never
Function → Button operation 	Brightness/call up scenario/season
Function → Button operation 	Fan/season for Fan: - V1, V2, V3, Auto (if associated with 3-speed fan coil) - 33%, 66%, 100% cycle, Auto (if associated with proportional fan coil)

Menu	Parameters
Function → Fan coil speed band	From 1 °C to +3 °C, in 0.1°C steps (both for 3-speed and proportional fan coils)
Function → Fan coil actuation delay time	From 0 a 240 s in 1 s steps (both for 3-speed and proportional fan coils)
Climate control → Type of algorithm	OnOff/PID
Climate control → Hysteresis	From 0.1 °C to 1.0 °C, in 0.1°C steps (only if Type of algorithm is OnOff)
Climate control → Proportional band	From 0.5 °C to 5.0 °C, in 0.1°C steps (only if Type of algorithm is PID)
Climate control → Integrative time	From 5 to 120 min, in 1-min steps (only if Type of algorithm is PID)
Climate control → Derivative time	From 0 a 255 s in 0.1s steps (only if Type of algorithm is PID)
Climate control → Cycle time	From 10 to 30 min, in 1-min steps (only if Type of algorithm is PID)

The View Wireless App can be used to associate a magnetic or wired contact of art. 03980 or an input of the 3in 1out module 03983 to turn off the temperature control system in the event of an open window; in this case, the time for reaction and reactivation of contact opening and closing (Window reaction time and Window reactivation time) can be set:

The View or View Wireless App can be used to set:

- Time schedules (times and temperature levels T1, T2 and T3)
- Setpoint for all operating modes (Manual, Reduction, Economy, Protection)
- Manual operation time: between 1 min and 23 hours (with 1-min steps); default = 60 min
- Scedd, exclusive Text, average functions.

OPERATION IN Zigbee technology MODE.

If Zigbee technology is being used, associate the device directly with a ZigBee Gateway (for instance Amazon Echo Plus, SmartThings Hub). The following parameters can be configured:

- Lighting in standby: high, medium, low, off; default setting = medium
- Ring indication selection: automatic or monochrome; default setting = automatic
- RGB colour selection: you can choose the colour for the monochrome setting
- Temperature calibration for heating: from -5°C to +5°C; default setting = 0°C
- Temperature calibration for cooling: from -5 °C to +5 °C; default setting = 0 °C

USE.

The front buttons, the display, the dial and the lighting of the ring around the display can be used to set and display all the operating modes of the thermostat.

Use the dial to set a new setpoint. In particular, for operation in Bluetooth technology:

- in automatic operating mode, turn the dial for the thermostat to switch to manual operation for a period of time which can be set on the View App;
- with automatic operating mode, when the early switch-on function is enabled, the timed manual mode is available with a fixed time which is defined by the advance algorithm.
- in manual operation or reduction mode, the thermostat remains in this mode and the setpoint is that set on the dial.
- The thermostat can manage one or more thermostatic heads 03989 or the fans of a fan coil via actuators art. 03985 or art.03986.

REGULATORY COMPLIANCE.

RED Directive. RoHS directive. ErP directive.

EN 60730-2-7, EN 60730-2-9, EN 301 489-17, EN 300 328, EN 62479, EN 63000 standards.

Vimar SpA declares that the radio equipment complies with Directive 2014/53/EU. The full text of the EU declaration of conformity is on the product sheet available on the following website: www.vimar.com

Temperature control device regulation (EU) no. 811/2013.

REACH (EU) Regulation no. 1907/2006 – Art.33. The product may contain traces of lead.



WEEE - User information

The crossed bin symbol on the appliance or on its packaging indicates that the product at the end of its life must be collected separately from other waste. The user must therefore hand the equipment at the end of its life cycle over to the appropriate municipal centres for the differentiated collection of electrical and electronic waste. As an alternative to independent management, you can deliver the equipment you want to dispose of free of charge to the distributor when purchasing a new appliance of an equivalent type. You can also deliver electronic products to be disposed of that are smaller than 25 cm for free, with no obligation to purchase, to electronics distributors with a sales area of at least 400 m². Proper sorted waste collection for subsequent recycling, processing and environmentally conscious disposal of the old equipment helps to prevent any possible negative impact on the environment and human health while promoting the practice of reusing and/or recycling materials used in manufacture.

The Apple, iPhone and iPad logos are trademarks of Apple Inc., registered in the United States and in other Countries and Regions. App Store is a service trademark of Apple Inc.

Google is a trademark of Google LLC.

Amazon, Alexa and all related logos are trademarks of Amazon.com, Inc. or its affiliates.

CONNECTION WITH CIRCULATION PUMPS, BURNERS, FAN COILS, SOLENOID VALVES AND TEMPERATURE PROBE

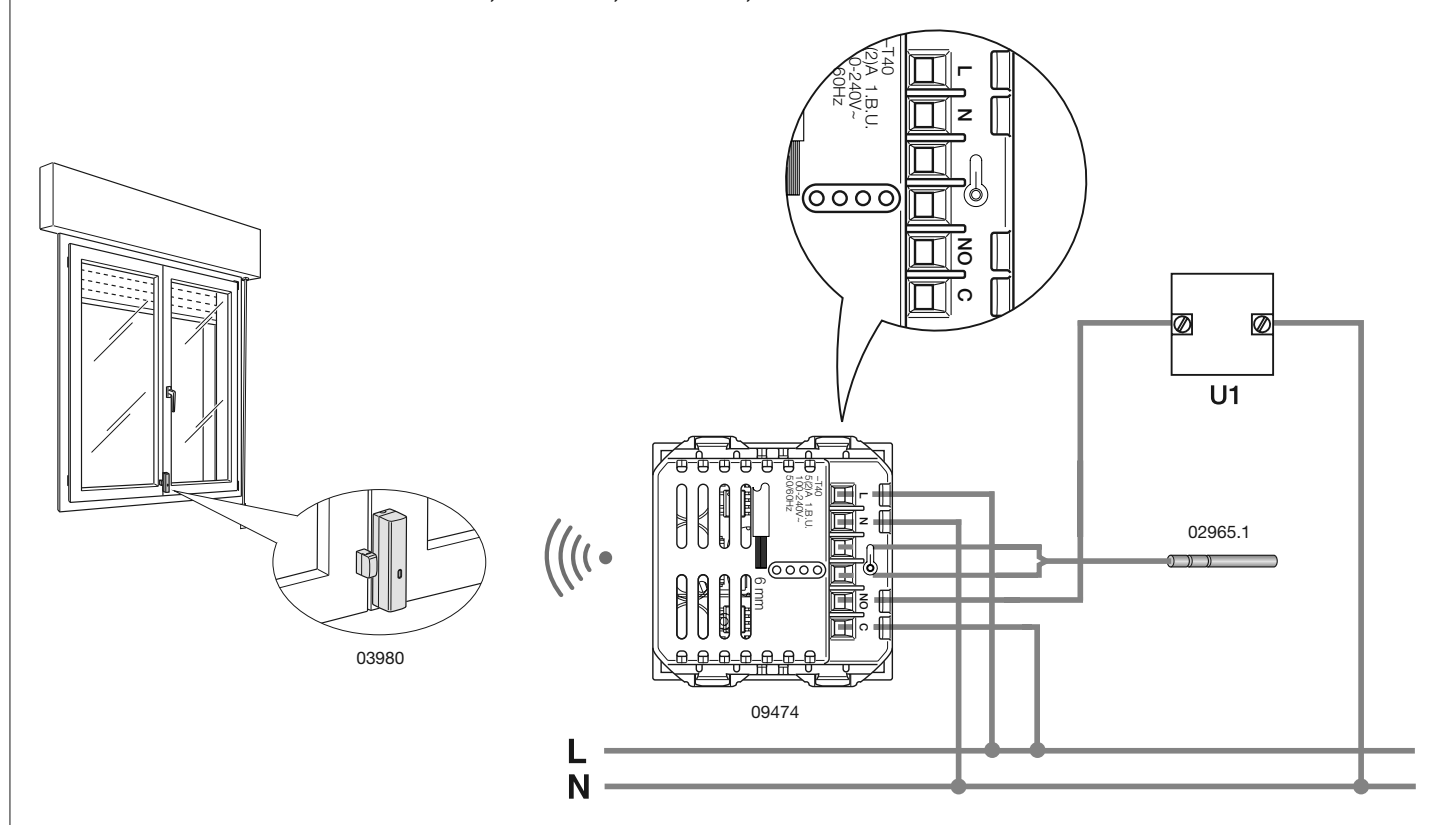

EXAMPLE OF USE

1. Thermostat climate control zone management

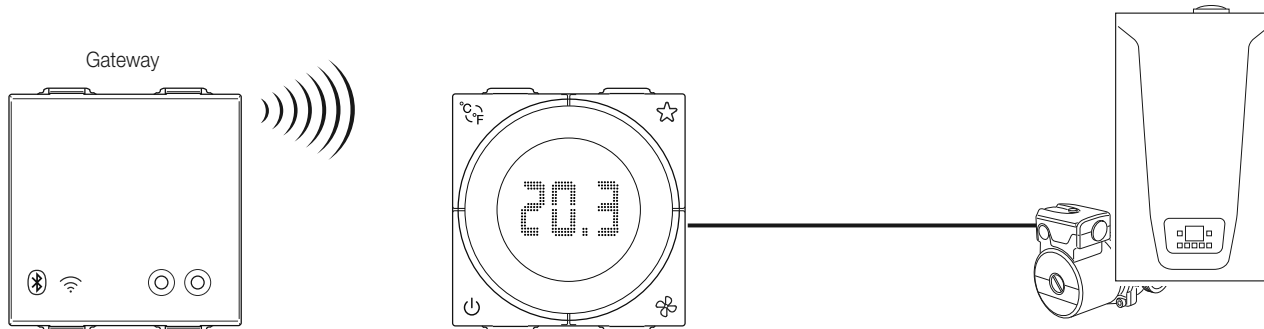

There is no need to create a group in the View Wireless App

2. Window contact management

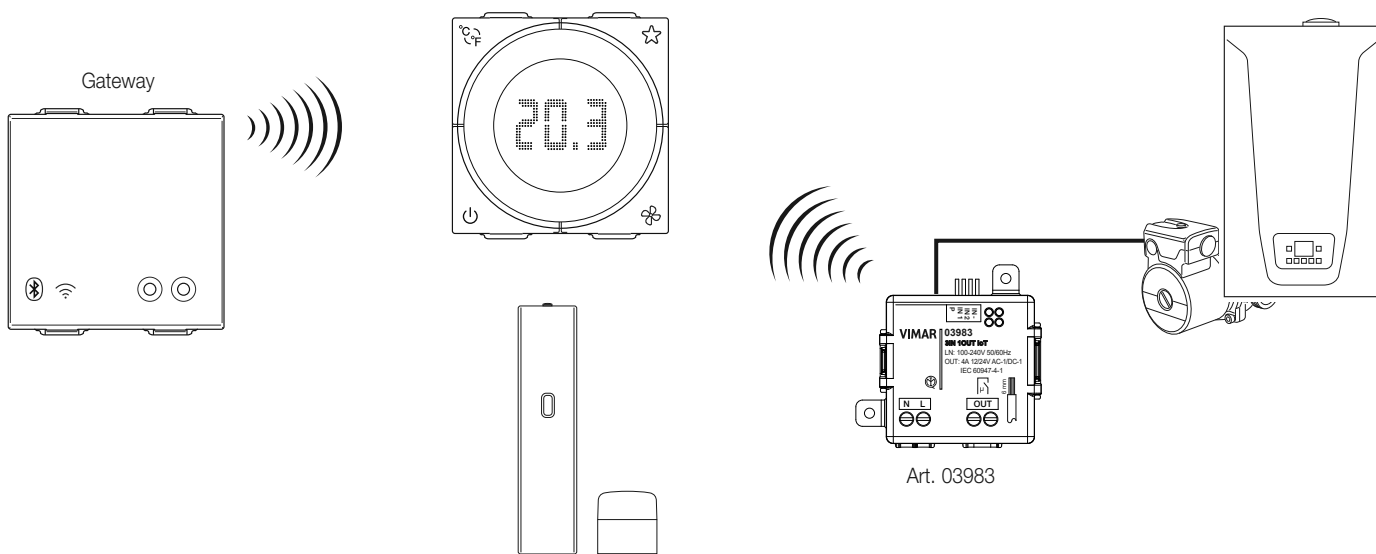

This type of application requires the presence of at least one magnetic contact 03980 and module 03983.

In the View Wireless App, create the Climate Control group → Window contact and the Climate Control group → Remote relays and Heads
In the View App, the group will be displayed in "Accesses and Presences" as an entrance or in "Sensors".

3. Climate control from thermostat associated with head

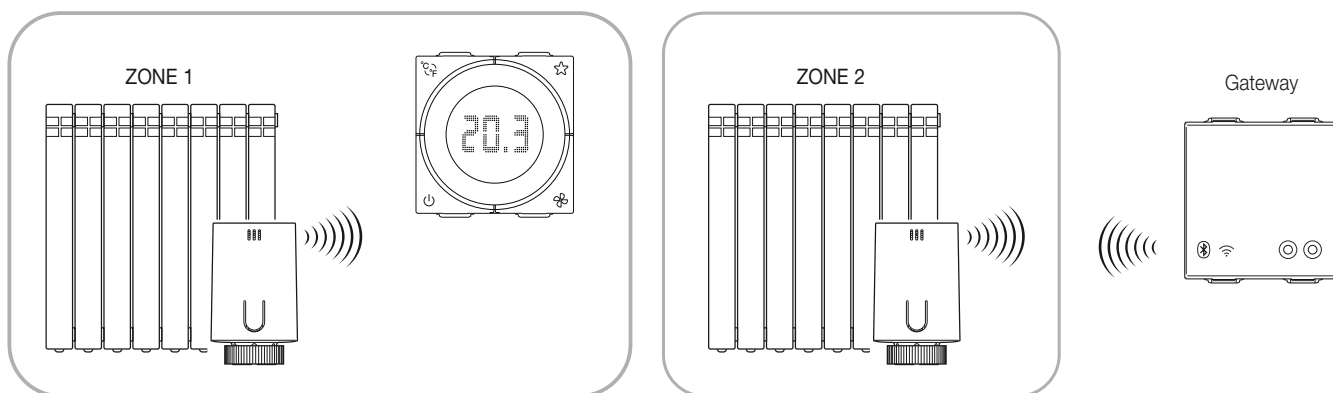

The ZONE 1 head should be configured as "Associated with thermostat".

The ZONE 2 head should be configured as independent.

This type of application can only be "Winter" and is configured in the View Wireless App by creating the Climate Control group → Remote relays and Heads → Winter → Relay

4. Summer circulation pump management from thermostat and one relay

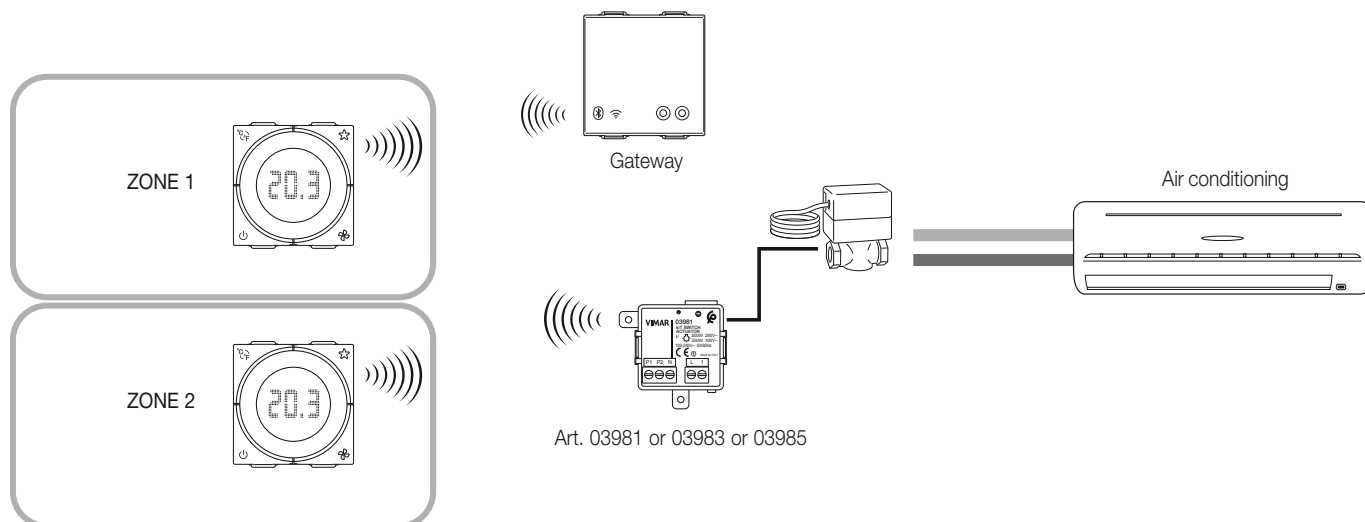

This type of application requires at least one thermostat and one of either art. 03981, 03983 or 03985 is required to control the circulation pump, as it provides consent to the boiler/ circulation pump.

In the View Wireless App, create the Climate Control group → Circulation pump → Summer

5. Winter circulation pump management from thermostat and/or head and one relay

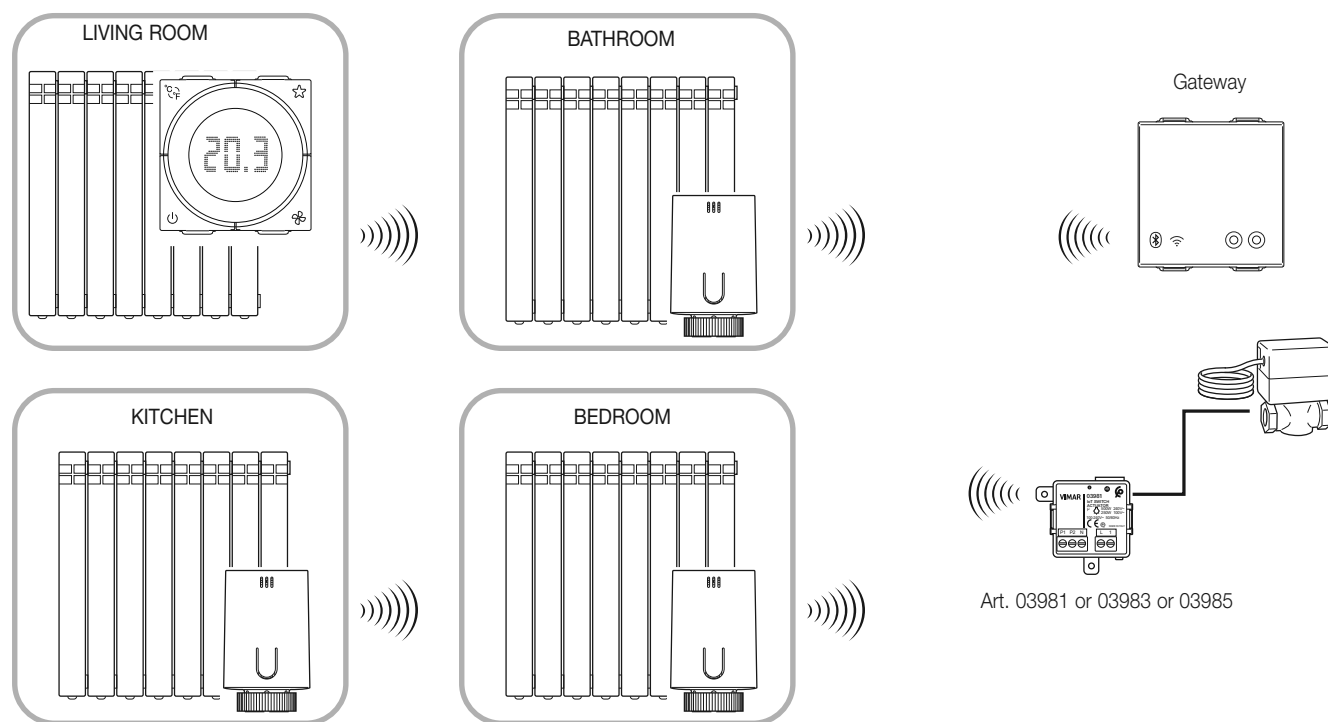

This type of application can only be "Winter" and requires that at least one thermostat and head are independent.

One of either art. 03981, 03983 or 03985 should be used to control the circulation pump and a "Circulation pump" group needs to be created, including the relay and the heads. Although the presence of art. 03981, 03983 or 03985 is optional for the application, it is necessary since it is the only mains powered device that can act as a repeater.

In the View Wireless App, create the Climate Control group → Circulation pump → Winter

6. Climate control from thermostat and one relay per valve (independent climate control zones)

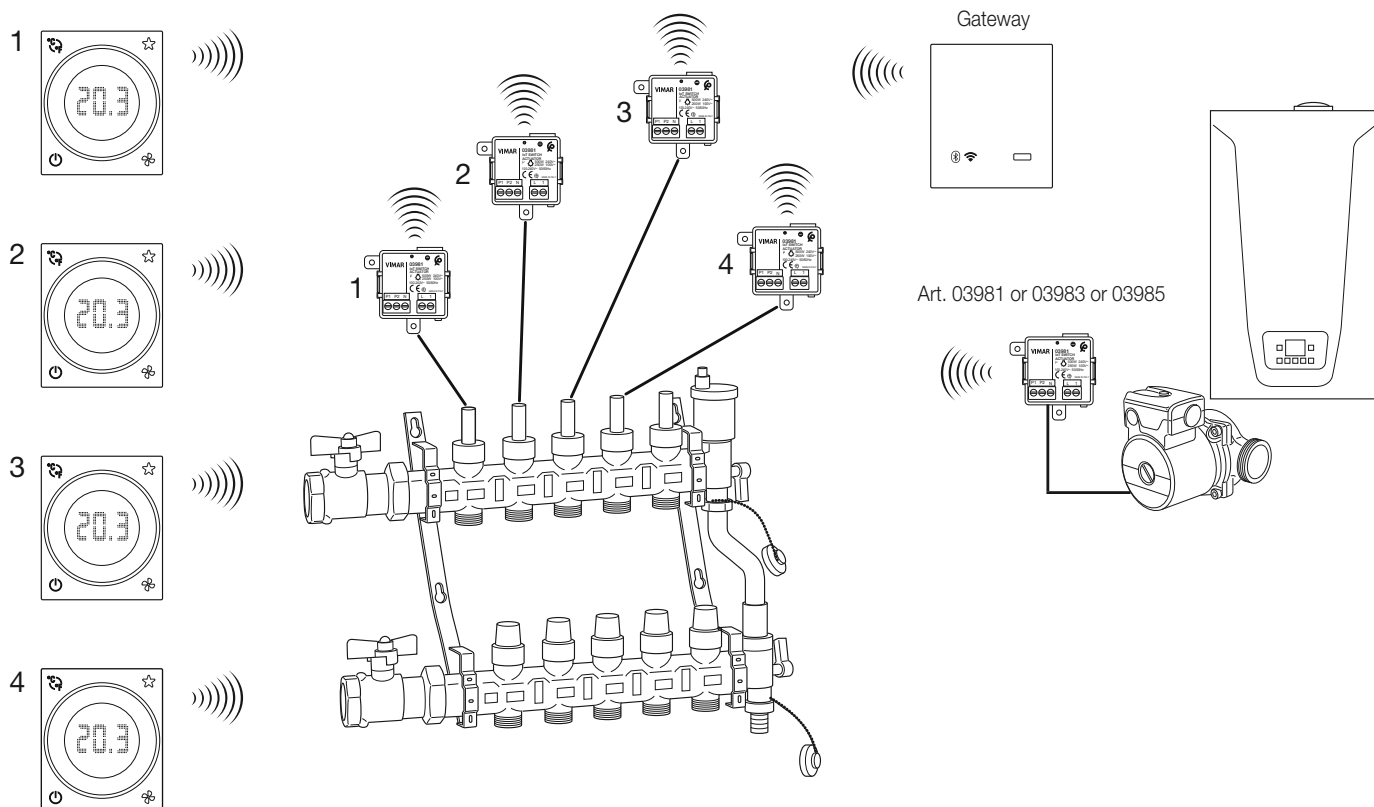

This type of application can either be "Summer" or "Winter" and the thermostat should be set with its output configured as a remote relay; use one of either art. 03981, 03983 or 03985 configured as a remote actuator for "consent to boiler/circulation pump" to control the valves.

In the View Wireless App, create the Climate Control group → Remote relays and Heads → Summer/Winter → Relay

7. Climate control from thermostat associated with two heads and one relay for "zone consent"

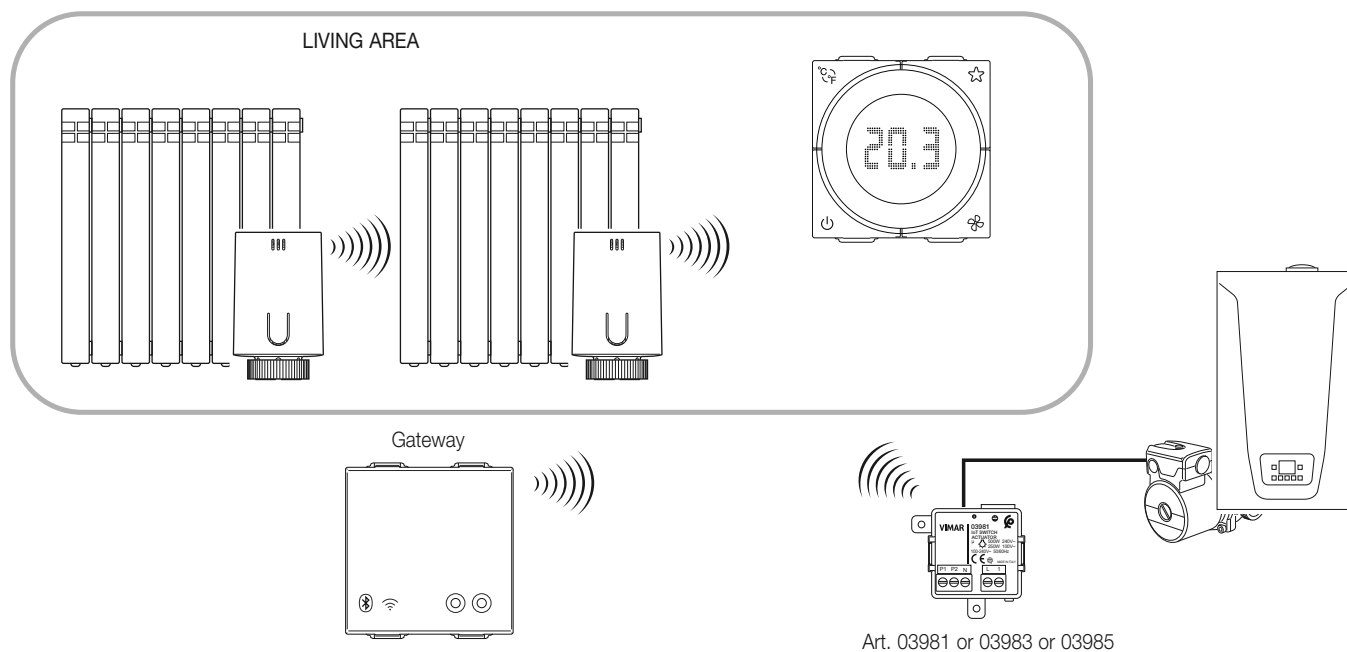

Configure the heads as "Associated with thermostat".

This type of application can only be "Winter" and use one of either art. 03981, 03983 or 03985 to control the valves.

In the View Wireless App, create the Climate Control group → Remote relays and Heads → Winter → Relay

8. 3-speed fan coil management

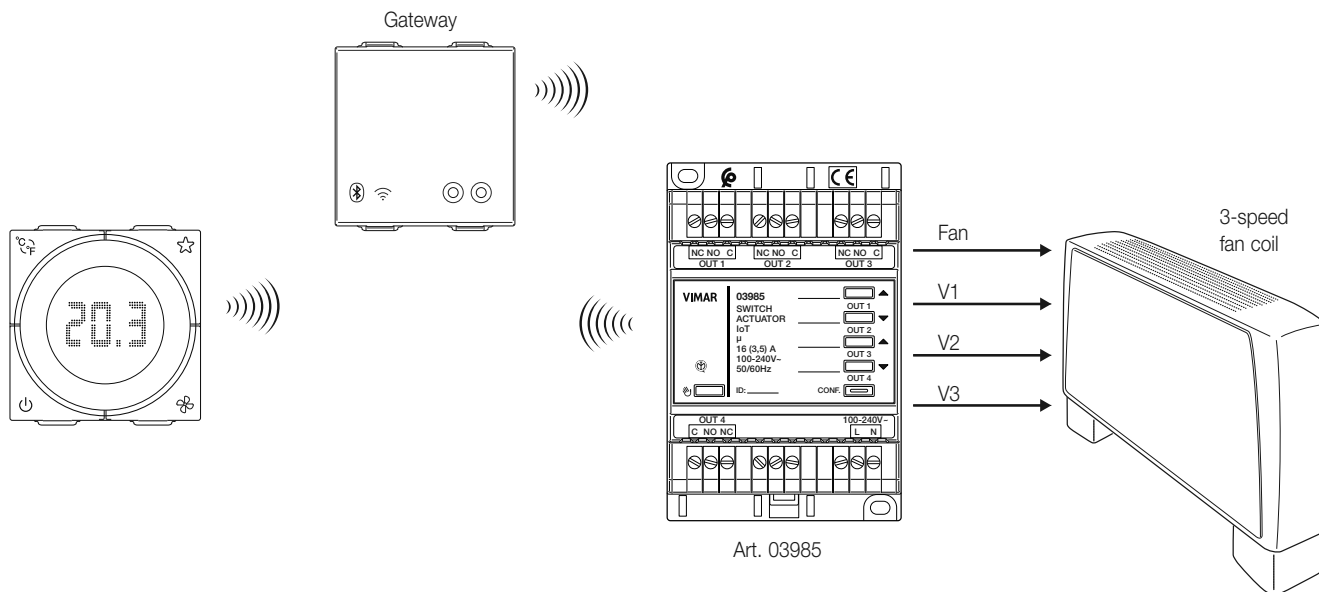

This type of application can either be "Summer" or "Winter" and the thermostat should be set with its output configured as a 3-speed fan coil; use actuator 03985 to control the fan coil. In the View Wireless App, create the Climate Control group → Remote relays and Heads → Summer/Winter → 3-speed fan coil

9. Proportion fan coil management

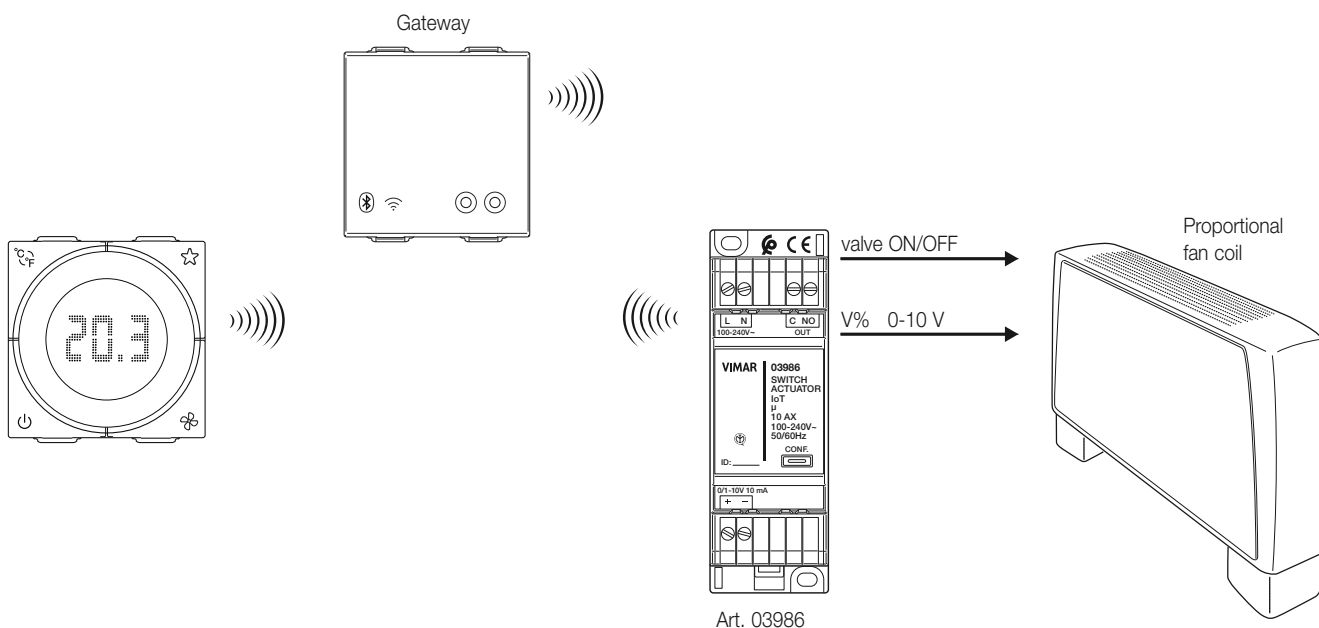

This type of application can either be "Summer" or "Winter" and the thermostat should be set with its output configured as a proportional fan coil; use actuator 03986 to control the fan coil. In the View Wireless App, create the Climate Control group → Remote relays and Heads → Summer/Winter → proportional fan coil