

To be completed with two interchangeable half-button caps: 1 module.

The front buttons of the device only control the on-board dimmer:

- Short press: dimmer on (UP button) or off (DOWN button)
- Long press: dimming of load (UP button = increase; DOWN button = decrease)

IMPORTANT: Lamps controllable from a single dimmer must all be the same. All controllable loads must be declared DIMMABLE by the manufacturer. Check the type of compatible dimming on the lamp packaging: LE (Leading Edge) or TE (Trailing Edge). Where not specified, the lamp works in both modes, at the discretion of the installer; choose the type of dimming that ensures the best lamp operation.

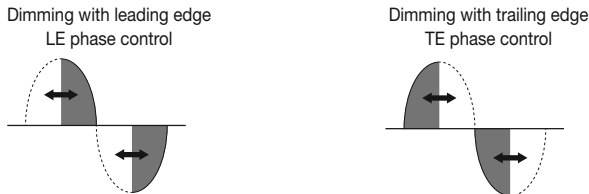

CAUTION: Until the device is configured ( **Bluetooth**[®] or  **zigbee**), its operation is limited to ON/OFF; this allows you to install a dimmable lamp at a later date and configure the dimmer correctly.



TWO OPERATING MODES (ALTERNATIVE)

 **Bluetooth**[®] or  **zigbee**



Download the View Wireless  App from the stores onto the tablet/smartphone you will be using for configuration.

When the device is powered for the first configuration, we recommend you search for any new firmware and perform the update.

Depending on the mode you select, you will need:

 Bluetooth [®]	 zigbee
Gateway art. 09597	Smart Home Hub
View App  for management via smartphone/tablet	Samsung SmartThings Hub Amazon Echo Plus, Eco Show or Echo Studio
Amazon Alexa, Google Assistant, Siri (Homekit) voice assistants for possible voice operation	

CONFIGURATION IN **Bluetooth**[®]

1. Create your account on MyVimar (on-line).
2. Wire all the devices in the system (2-way switches, actuators, dimmers, thermostats, gateway, etc.).
3. Start the View Wireless App and log in with the credentials you just created.
4. Create the system and the environments.
5. Associate all the devices with the environments, except for the gateway (which should be associated last).
To associate the dimmer:
 - Select "Add" (), choose the environment to place it and give it a name
 - Select  : activate the Bluetooth connection on your tablet/smartphone and approach the device
 - Simultaneously press the UP and DOWN buttons and set the desired function
6. For every device, set the function, the parameters and any accessory devices (wired or radio control and related function).
7. Transfer the configuration of the devices to the gateway and connect it to the Wi-Fi network.
8. Transfer the system to the Administrator user (who must have created his/her profile on MyVimar).

For details please refer to the View Wireless App manual you can download from www.vimar.com → DOWNLOAD → View Wireless MOBILE → App

CONFIGURATION IN **zigbee**

Follow the procedure above from points 1 to 3.

Associate the device directly to a ZigBee Hub (e.g. Amazon Echo Plus, SmartThings Hub)

- 1) Simultaneously press the buttons on the device until the LED flashes and download the Zigbee software using the View Wireless App (see the View Wireless App manual). To update the software on the device, the procedure is the same.
- 2) After conversion to Zigbee technology (or the software update), the device automatically goes into pairing mode so that it can be recognised by the Amazon device within 5 minutes. If the device is not in pairing mode, cut off the power supply and restore it after a few seconds.

- 3) Associate the module according to the procedure envisaged by the ZigBee Hub (see the Hub's manufacturer documentation).

Set the dimmer parameters.

- 1) Within the first 5 minutes after the device has been powered (already associated with ZigBee Hub), simultaneously press the UP and DOWN buttons for 15 s; this starts the configuration for choosing the LE/TE mode. The LED will flash green to indicate the LE operating mode; briefly press one of the buttons to switch to TE mode and the LED will flash amber. Each time one of the buttons is subsequently pressed, the device will switch from TE to LE mode in a cyclic manner, the load remains on but the actual setting occurs when you confirm the chosen mode. Once you have chosen the latter, simultaneously press the UP and DOWN buttons for 5 s to confirm and move on to the next step of the configuration process.
Note: During the phase, a 2-minute timeout will be activated, after which, if the user has not made any setting, the operation will end and the previous parameter retained; the load will be switched on at minimum and the LED will assume the colour of the respective wiring series.
- 2) You now begin the configuration of the minimum brightness; the LED lights up magenta and the load is activated at minimum level. Press the UP button to increase the brightness, or press the DOWN button to decrease it; short presses will increase or decrease the brightness in minimum steps, whereas long presses will set it according to a ramp. Once you have chosen the brightness, simultaneously press the UP and DOWN buttons for 5 s to confirm and move on to the next step of the configuration process.
Note: During this phase too, a 2-minute timeout will be activated, after which, if the user has not made any setting, the operation will end and the previous parameter retained; the load will be switched on at minimum and the LED will assume the colour of the respective wiring series.
- 3) You now begin the configuration of the behaviour of the LED for visible in darkness; the LED will flash cyan and the load is turned off. Briefly press one of the buttons to set the switching on of the LED when it gets dark, whereas pressing it again will switch it off; each subsequent pressing of one of the buttons will switch from the LED being on in the dark to the LED being off, in a cyclic manner. Once you have chosen the behaviour of the LED, simultaneously press the UP and DOWN buttons for 5 s to confirm; the LED will quickly flash cyan three times and configuration is now complete. The load will switch on at minimum and the LED will assume the colour of the respective wiring series.
Note: During this phase too, a 2-minute timeout will be activated, after which, if the user has not made any setting, the operation will end and the previous parameter retained.

Summary of Zigbee technology mode signalling.





- During normal operation:

LED	Meaning
On	Dimmer on
Off	Dimmer off
ON at minimum if the visible in darkness mode is set	

- In the configuration phase:

LED	Meaning
Flashing white (for max 5 min.)	Zigbee mode active hub gateway association
Flashing blue (for max 2 min.)	Pending receipt of a fw update
Blue permanently lit	Device associated with the smartphone via Bluetooth
Flashing green during the LE/TE configuration	LE Mode
Flashing amber during the LE/TE configuration	TE Mode
Magenta permanently lit	LE/TE configuration saved and start of minimum brightness configuration
Cyan permanently lit	Minimum brightness configuration saved and start of LED visible in darkness configuration
Flashing cyan	LED visible in darkness ON
Off	LED visible in darkness OFF
Flashing cyan quickly 3 times	Configuration complete
Flashing green quickly 3 times	Device correctly associated with the voice assistant
On	Load on

CONTROLLABLE LOADS AT 220-240 V~, 50/60 Hz.

Controllable loads	LE	TE
	20 - 200 W	20 - 200 W
	2 - 100 W (max 10 lamps)	2 - 200 W (max 20 lamps)
	20 - 100 W (max 3  type transformers)	20 - 200 W (Max 5 transformers type )
Power supply units 01874-01875	max 10 power supply units	Not applicable
Dimmable power supply units for LED	2 - 75 W (max 2 power supply units)	2 - 200 W (max 2 power supply units)

N.B The device also performs dimming on LED strips provided that they are operated by power supply units for LED, declared dimmable and compatible with LE/TE control by the manufacturer.

RESETTING THE DEVICE.

The reset restores the factory settings. Within the first 5 minutes from powering, simultaneously press the UP and DOWN buttons for 30 s until the white LED flashes.

CONNECTIONS.

Control and dimming using incorporated push buttons or from several points with parallel NO push buttons. Do not use NO buttons with pilot light.



CAUTION: The ON/OFF PUSH BUTTON MUST BE CONNECTED TO THE NEUTRAL CONDUCTOR.

INSTALLATION RULES.

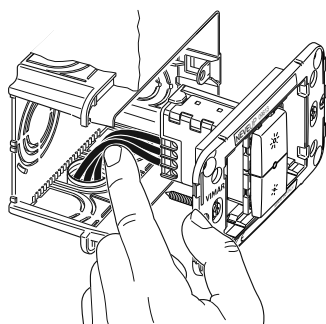
- Installation and configuration must be carried out by qualified persons in compliance with the current regulations regarding the installation of electrical equipment in the country where the products are installed.
- The device must be completed with interchangeable buttons and installed in flush mounting boxes or surface mounting boxes with Neve Up mounting frames and cover plates.
- The device must be protected against overloads by installing a device, fuse or automatic 1-way switch, with a rated current not exceeding 10 A.
- Installation must be carried out with the system switched off. **Install the buttons onto the dimmer control before powering up the system.**
- The dimmer does not have a mechanical 1-way switch in the main circuit and so is not galvanically separated. The circuit load should be considered always powered.
- Push the connection conductors on the base of the mounting box to avoid them touching the body of the dimmer.

CHARACTERISTICS

- Rated supply voltage: 220-240 V~, 50/60 Hz.
- RF transmission power: < 100 mW (20 dBm)
- Frequency range: 2400-2483.5 MHz
- Terminals:
 - 2 terminals (L and N) for line and neutral
 - 1 terminal (P) for connection to the remote wired control (for instance art. 09008). **The max distance between the IoT device and the push button is 50 m with a cable with a minimum cross-section of 1.5 mm².**
 - 1 terminal for dimmed output
- 2 front buttons that are used both to control the load and as configuration push buttons.
- RGB LED indicating the load status (which can be set from the View Wireless App) and the configuration status (flashing blue)
- In Bluetooth technology mode, they can be associated with the device:
 - up to 16 connected controls (art. 09591.0)
 - up to 2 radio controls (art. 03925)
 allowing actuator control or activation of a scenario.
- ON, OFF and dimming of the load via:
 - electronic connected controls (art. 09591.0)
 - built-in push buttons or normal non-luminous closing push buttons
- Soft start: which guarantees the gradual shift from off state to maximum brightness or to the state set previously.

- Soft end: slowly brings the load down from on to off.
- Leading edge (LE) phase cutting dimming: to be used with incandescent lamps or compatible LED lamps, and type  electronic transformers.
- Trailing edge (TE) phase cutting dimming: to be used with incandescent lamps or compatible LED lamps and type  electronic transformers.
- Protection against short-circuit together with flashing-lamp blow-out detector
- Thermal protection with flashing-lamp blow-out detector.
- It should be used in dry, dust-free places at a temperature of between 0 °C and +35 °C.
- If installing 2 dimmers in a single mounting box, the controllable loads by each dimmer must be reduced so that their total does not exceed the maximum power that can be controlled by a single device.
- Protection degree: IP20
- Configuration from View Wireless App for Bluetooth technology system and Amazon App for Zigbee technology.
- Controllable via View App (for Bluetooth technology) and Amazon Alexa (for Zigbee technology).

OPERATION IN Bluetooth technology MODE.

The device operates by default in Bluetooth technology mode and this standard makes it possible to:

- recall a scenario using the traditional push button connected to the device;
- associate the radio control 03925 which can be configured to control the actuator on-board or to recall a scenario.
- associate the control 09591.0 to operate the dimmer from several points.

Through the use of gateway 09597 the functions can be managed locally or remotely via the View App, and the control is also available via the voice assistants Amazon Alexa, Google Assistant and Siri.

The device is also compatible with HomeKit.

N.B.: The device works as a repeater node for battery-operated devices (for instance art. 03980).

Settings.

The View Wireless App can be used to set the following parameters:

- RGB LED for backlighting: colour can be selected from a default list.
- LED brightness: off, low, medium, high for dimmer on (default: high) and for dimmer off (default: off).
- LE or TE operating mode (default: LE)
- Minimum operating value (default 25%)
- Soft Start up time (default 1s)
- Soft Stop down time (default 1s)
- Dimming time: time to switch from one value to the next (default 1s)
- Scenario activation delay time (default: 0 s).
- One-position stable activation time (default: 60 s).
- Dimming speed: Low, Medium, High (default: Medium).

REGULATORY COMPLIANCE.

RED Directive. RoHS directive.

Standards 60669-2-1, EN 301 489-17, EN 300 328, EN 62479, EN IEC 63000.

Vimar SpA declares that the radio equipment complies with Directive 2014/53/EU. The full text of the EU declaration of conformity is on the product sheet available on the following website: www.vimar.com

REACH (EU) Regulation no. 1907/2006 – Art.33. The product may contain traces of lead.



WEEE - User information

The crossed bin symbol on the appliance or on its packaging indicates that the product at the end of its life must be collected separately from other waste. The user must therefore hand the equipment at the end of its life cycle over to the appropriate municipal centres for the differentiated collection of electrical and electronic waste. As an alternative to independent management, you can deliver the equipment you want to dispose of free of charge to the distributor when purchasing a new appliance of an equivalent type. You can also deliver electronic products to be disposed of that are smaller than 25 cm for free, with no obligation to purchase, to electronics distributors with a sales area of at least 400 m². Proper sorted waste collection for subsequent recycling, processing and environmentally conscious disposal of the old equipment helps to prevent any possible negative impact on the environment and human health while promoting the practice of reusing and/or recycling materials used in manufacture.

Apple HomeKit is a trademark of apple Inc. App Store is a service mark of Apple Inc. To control this HomeKit-enabled accessory, iOS 9.0 or later is recommended. Controlling this HomeKit-enabled accessory automatically and away from home requires an apple TV with tvOS 10.0 or later or an iPad with iOS 10.0 or later or a HomePod/Siri set up as a home hub.

The Apple logo, iPhone, and iPad are trademarks of Apple Inc., registered in the U.S. and other countries and regions. App Store is a service mark of Apple Inc. Google, Google Play and Google Home are trademarks of Google LLC. Amazon, Alexa and all related logos are trademarks of Amazon.com, Inc. or its affiliates.

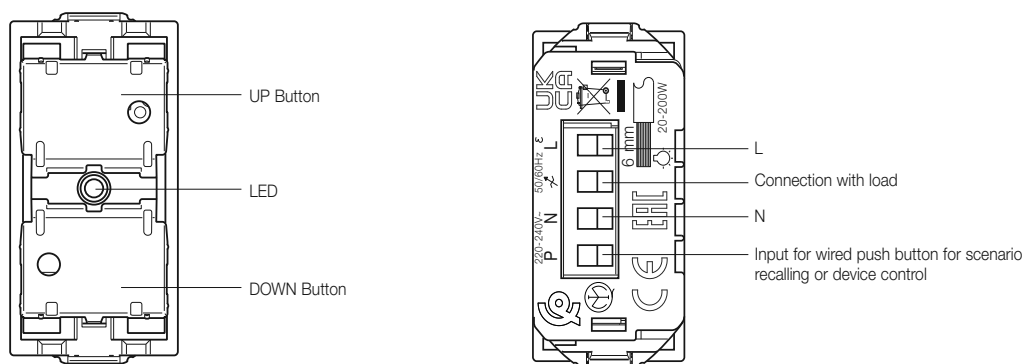
FRONT AND BACK VIEW



CONNECTIONS

PUSH BUTTON* FOR SCENARIO CONTROL OR DEVICE CONTROL

CONNECTED CONTROL

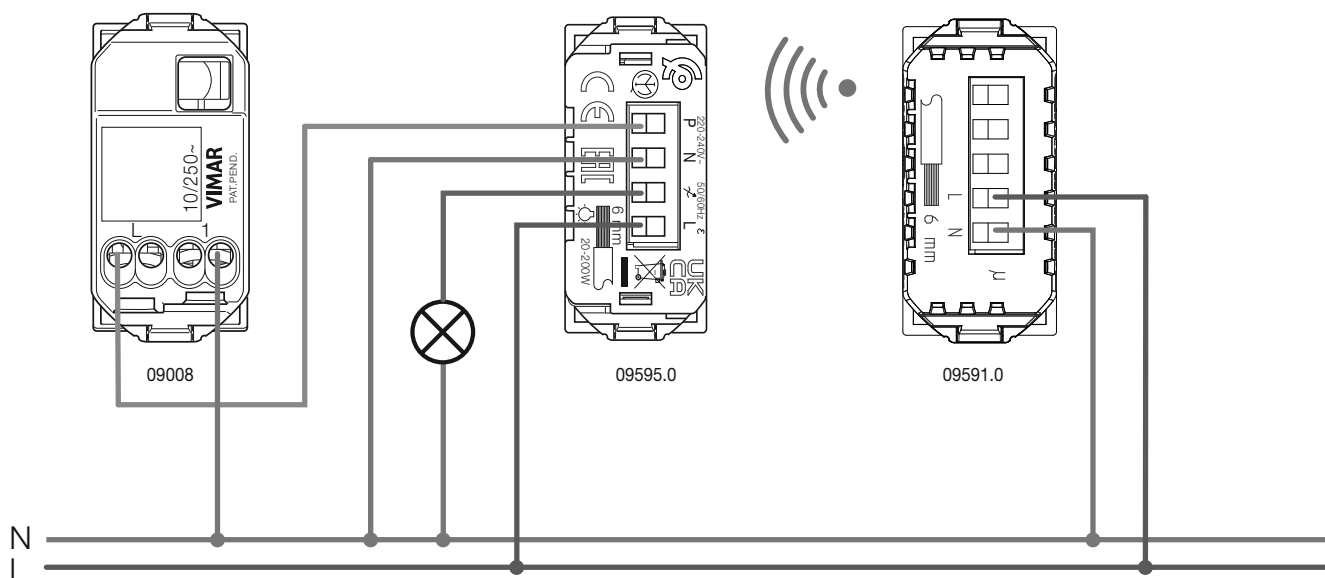

* Do not use the signalling unit 00931.