

ESM4

USER MANUAL

MANUAL RELEASE

- To release the actuator, lift the release cover A
- Place key B in the lock
- Turn the key in the direction indicated by the arrow

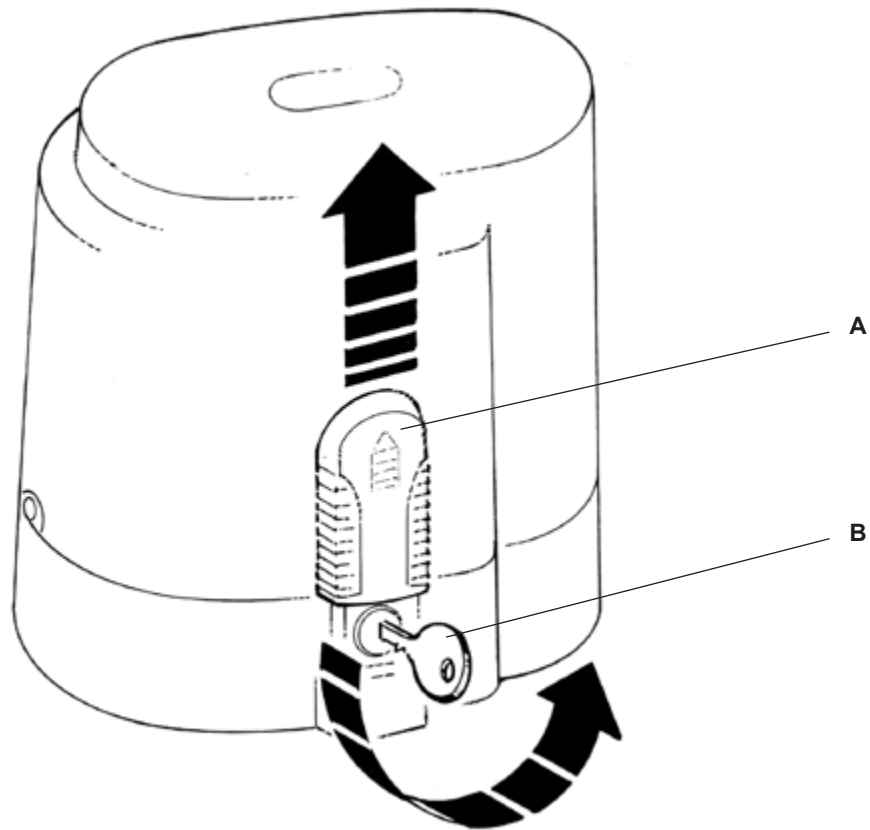

Association of the remote control buttons

	Button 1 function	Button 2 function	Button 3 function	Button 4 function
Radio control 1				
Radio control 2				
Radio control 3				
Radio control 4				

